

Analysis Guidebook

Pharmaceutical Analyses





1. General Pharmaceuticals

1. 1 Analysis of Anti-Epilepsy Drug - GC..... 1
1. 2 Analysis of Antispasmodic Drug - GC..... 2
1. 3 Analysis of Sedative Sleeping Drug and Intravenously Injected Anesthetic - GC... 3
1. 4 Analysis of Cold Medicine - GC..... 4
1. 5 Analysis of Chlorpheniramine Maleate in Cold Medicine - GC..... 5
1. 6 Headspace Analysis of Volatile Elements in Pharmaceuticals and Non-Pharmaceutical Products (1) - GC.... 6
Headspace Analysis of Volatile Elements in Pharmaceuticals and Non-Pharmaceutical Products (2) - G..... 7
Headspace Analysis of Volatile Elements in Pharmaceuticals and Non-Pharmaceutical Products (3) - GC.... 8
1. 7 Analysis of Pharmaceuticals Using Direct Sample Introduction Method, EI, CI and Mass Spectrometry (1) - GCMS.... 9
Analysis of Pharmaceuticals Using Direct Sample Introduction Method, EI, CI and Mass Spectrometry (2) - GCMS... 10
1. 8 Analysis of Pharmaceutical (Acetate Ester of Vitamin E) Using a Mass Spectrometer - GCMS.... 11
1. 9 Analysis of Cosmetics (1) - LC..... 12
Analysis of Cosmetics (2) - LC..... 13
Analysis of Cosmetics (3) - LC..... 14
- 1.10 Analysis of Hair Lotions (1) - LC..... 15
Analysis of Hair Lotions (2) - LC..... 16
- 1.11 Analysis of Synthetic Antibacterial Agents - LCMS..... 17



2. Antibiotics

2. 1 Analysis of Low-Volatile High-Mass Compound Using DI-MS - GCMS..... 19
2. 2 Analysis of Antibacterial Agents in Edible Meat - LC..... 20
2. 3 Analysis of Antibiotics and Synthetic Antibacterial Agents in Livestock and Farmed Fish (1) - LC... 21
Analysis of Antibiotics and Synthetic Antibacterial Agents in Livestock and Farmed Fish (2) - LC... 22
2. 4 Analysis of Pharmaceuticals for Animals (1)..... 23
Analysis of Pharmaceuticals for Animals (2)..... 24
Analysis of Pharmaceuticals for Animals (3)..... 25
Analysis of Pharmaceuticals for Animals (4)..... 26
2. 5 Analysis of Mixed Feed (1)..... 27
Analysis of Mixed Feed (2)..... 28



3. Crude drugs and Natural Substances

3. 1 Analysis of Capsaicin in Red Pepper Tincture - GC..... 29
3. 2 Analysis of Pharmaceutical (Beeswax) - GCMS..... 30
3. 3 Analysis of Capsaicin Using NCI-GC/MS (1) - GCMS..... 31
Analysis of Capsaicin Using NCI-GC/MS (2) - GCMS..... 32
3. 4 NCI-GC/MS Analysis of a Crude drug (Red Ginseng) - GCMS..... 33
3. 5 Measurement of Glycyrrhizin in Licorice - LCMS..... 34
3. 6 HPLC Analysis of a Crude drug (1) - LC..... 35
HPLC Analysis of a Crude drug (2) - LC..... 36
HPLC Analysis of a Crude drug (3) - LC..... 37



4. Clinical and Forensic Medicine

4. 1 Microanalysis of Cyanogens in Blood - GC..... 38
4. 2 Analysis of Antiarrhythmic Drug (1)..... 39
Analysis of Antiarrhythmic Drug (2)..... 40

4. 3 Analysis of Psychotropic Agent Chlorpromazine (1) - GC..... 41
Analysis of Psychotropic Agent Chlorpromazine (2) - GC..... 42
4. 4 Analysis of Psychotropic Agent Haloperidol - GC..... 43
4. 5 Analysis of Psychotropic Agent Imipramine and its Metabolic Substance - GC.... 44
4. 6 Analysis of Stimulant Drugs Using GC/MS - GCMS..... 45
4. 7 Mass Screening of Congenital Metabolic Disorder (Phenylketonuria) (1) - GCMS.... 46
Mass Screening of Congenital Metabolic Disorder (Propionic Acidemia and Methylmalonic Acidemia) (2) - GCMS.... 47
Mass Screening of Congenital Metabolic Disorder (Isovaleric Acidemia) (3) - GCMS... 48
4. 8 Emergency Testing Method for Acute Drug Overdose using DI/CI/MS - GCMS.... 49
4. 9 Analysis of Drugs Using Fast-GC/MS (1) - GCMS..... 50
Analysis of Drugs Using Fast-GC/MS (2) - GCMS..... 51
- 4.10 Analysis of Amphetamine and Methamphetamine..... 52



5. Others

5. 1 Application of Automatic Diffuse Reflectance Attachment for Confirmation Test (1) - FTIR.... 53
Application of Automatic Diffuse Reflectance Attachment for Confirmation Test (2) - FTIR.... 54
5. 2 Confirmation Test Using Program Conforming to Japanese Pharmacopoeia (1) - FTIR.... 55
Confirmation Test Using Program Conforming to Japanese Pharmacopoeia (2) - FTIR.... 56
5. 3 Analysis of Lead (Pb) in Refined White Sugar - AA..... 57
5. 4 Analysis of Lead (Pb) in Whole Blood - AA..... 58
5. 5 Quantification of Calcium (Ca) and Magnesium (Mg) in Energy Drink - AA.... 59
5. 6 Quantification of Vitamin B₁₂ (Cyanocobalamin) - AA..... 60
5. 7 Measurement of Enzyme Activity Using Shimadzu Spectrometer UV-3101PC - UV ... 61
5. 8 Introduction of Shimadzu Automatic Dissolution Test System ADM that Achieves High Efficiency in Dissolution Tests for Pharmaceuticals (1) - UV... 62
Introduction of Shimadzu Automatic Dissolution Test System ADM that Achieves High Efficiency in Dissolution Tests for Pharmaceuticals (2) - UV... 63
5. 9 Analysis of Histamine Using a Spectrofluorophotometer - RF..... 64
- 5.10 Purity Test and Confirmation Test Conforming to Japanese Pharmacopoeia - UV.... 65
- 5.11 Measuring Examples Using Protein Analysis Program Pack - UV..... 66
- 5.12 Enzyme Reaction Measurement Using Kinetics Software - UV..... 67
- 5.13 Measurement of High-Speed Reaction Using a Stopped-Flow Device and MultiSpec-1500 - UV... 68
- 5.14 Analysis of Pharmaceutical Residual Solvent (Observation of Separation) (1) - GC.... 69
Analysis of Pharmaceutical Residual Solvent (Observation of Separation) (2) - GC.... 70
- 5.15 Analysis of Pharmaceutical Residual Solvent According to <467> of United States Pharmacopoeia (USP) (1) - GC.... 71
Analysis of Pharmaceutical Residual Solvent According to <467> of United States Pharmacopoeia (USP) (2) - GC.... 72
Analysis of Pharmaceutical Residual Solvent According to <467> of United States Pharmacopoeia (USP) (3) - GC.... 73
- 5.16 Analysis of Pharmaceutical Residual Solvent (Standard Sample Analysis Using HS-GC) (1) - GC... 74
Analysis of Pharmaceutical Residual Solvent (2) - GC..... 75
- 5.17 Analysis of Residual Solvent in Powdered Medicine - GC..... 76
- 5.18 Analysis of Residual Solvent in Pharmaceutical Bulk - GC..... 77
- 5.19 Analysis of Ethylene Oxide in Antiseptic First Aid Adhesive Tape - GC..... 78
- 5.20 Simultaneous Analysis of Ascorbic Acid and Dehydroascorbic Acid (1) - LC... 79
Simultaneous Analysis of Ascorbic Acid and Dehydroascorbic Acid (2) - LC... 80
- 5.21 Amino Acid Analysis (1) - LC..... 81
Amino Acid Analysis (2) - LC..... 82
- 5.22 Application of Combinatorial Chemistry - FTIR..... 83



1. General Pharmaceuticals

1.1 Analysis of Anti-Epilepsy Drug - GC

•Explanation

This data introduces direct analysis of an anti-epilepsy drug without derivatization.

•Pretreatment

1g of anti-epilepsy drug is dissolved in 10mL of methanol, and 1 μ L of this solution is injected.

•Analytical Conditions

Instrument	: GC-14BPFsc
Column	: DB-1 30m \times 0.25mm i.d. df=0.25 μ m
Col.Temp.	: 230 $^{\circ}$ C
Inj.Temp.	: 300 $^{\circ}$ C
Det.Temp.	: 300 $^{\circ}$ C (FID)
Carrier Gas	: He 0.5mL/min
Injection	: Split 1:100

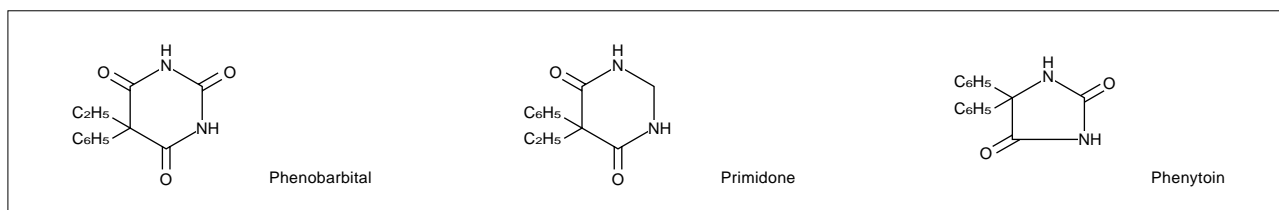

Fig. 1.1.1 Structural formula of elements in anti-epilepsy drug

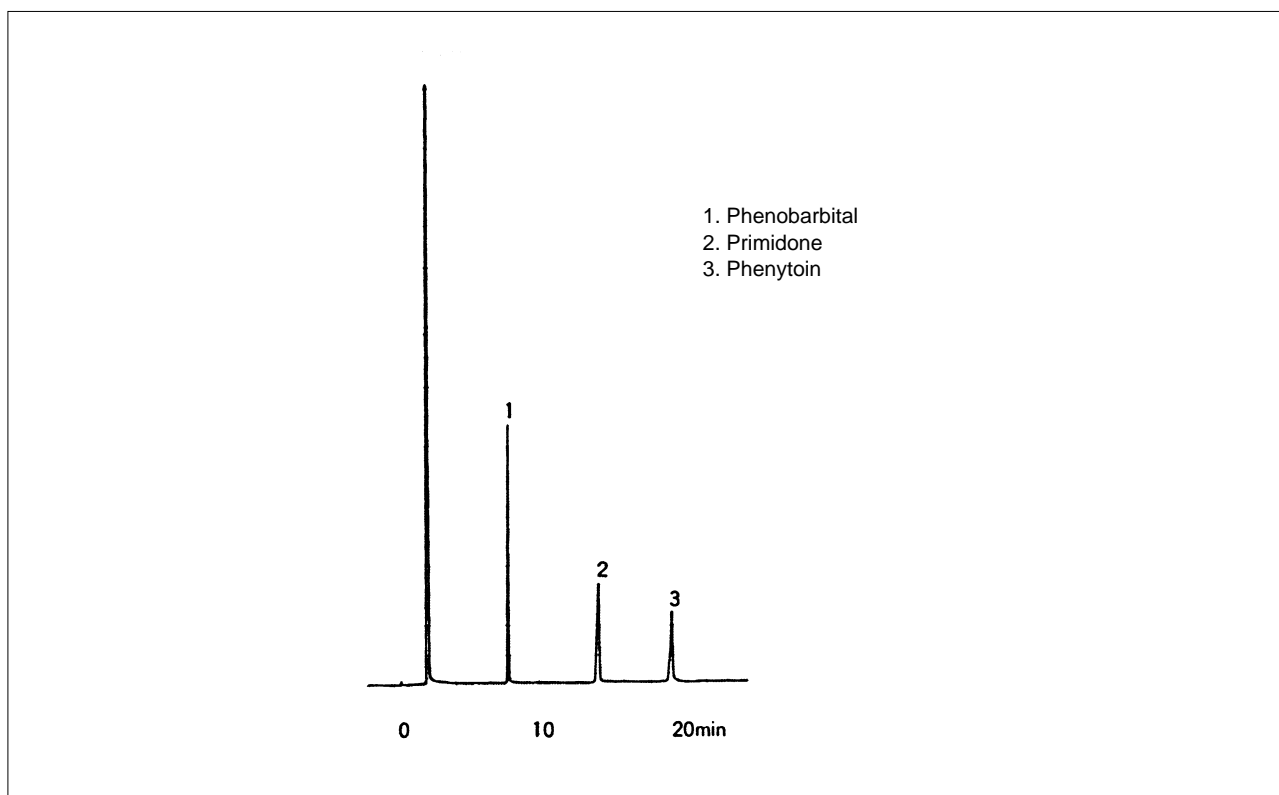

Fig. 1.1.2 Chromatogram of anti-epilepsy drug

1.2 Analysis of Antispasmodic Drug - GC

•Explanation

This data introduces direct analysis of an antispasmodic drug without derivatization.

•Pretreatment

1g of antispasmodic drug is dissolved in 10mL of methanol, and 1 μ L of this solution is injected.

•Analytical Conditions

Instrument	: GC-14BPFsc
Column	: DB-1 30m \times 0.25mm i.d. df=0.25 μ m
Col.Temp.	: 250 $^{\circ}$ C
Inj.Temp.	: 300 $^{\circ}$ C
Det.Temp.	: 300 $^{\circ}$ C (FID)
Carrier Gas	: He 0.5mL/min
Injection	: Split 1:100

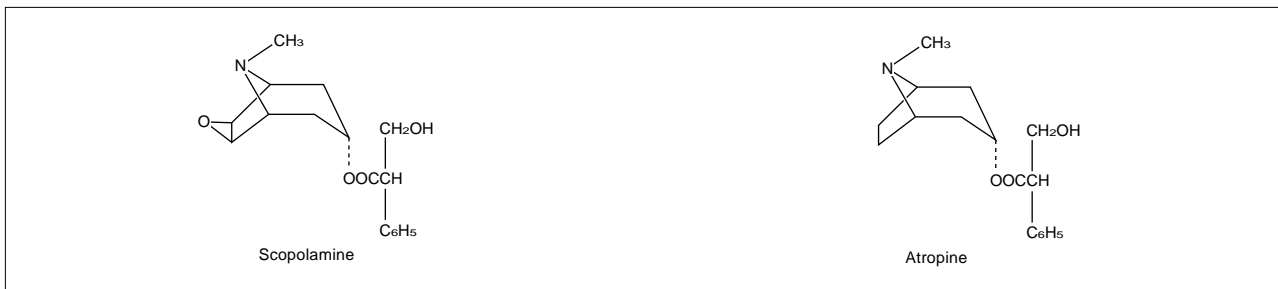

Fig. 1.2.1 Structural formula of scopolamine and atropine

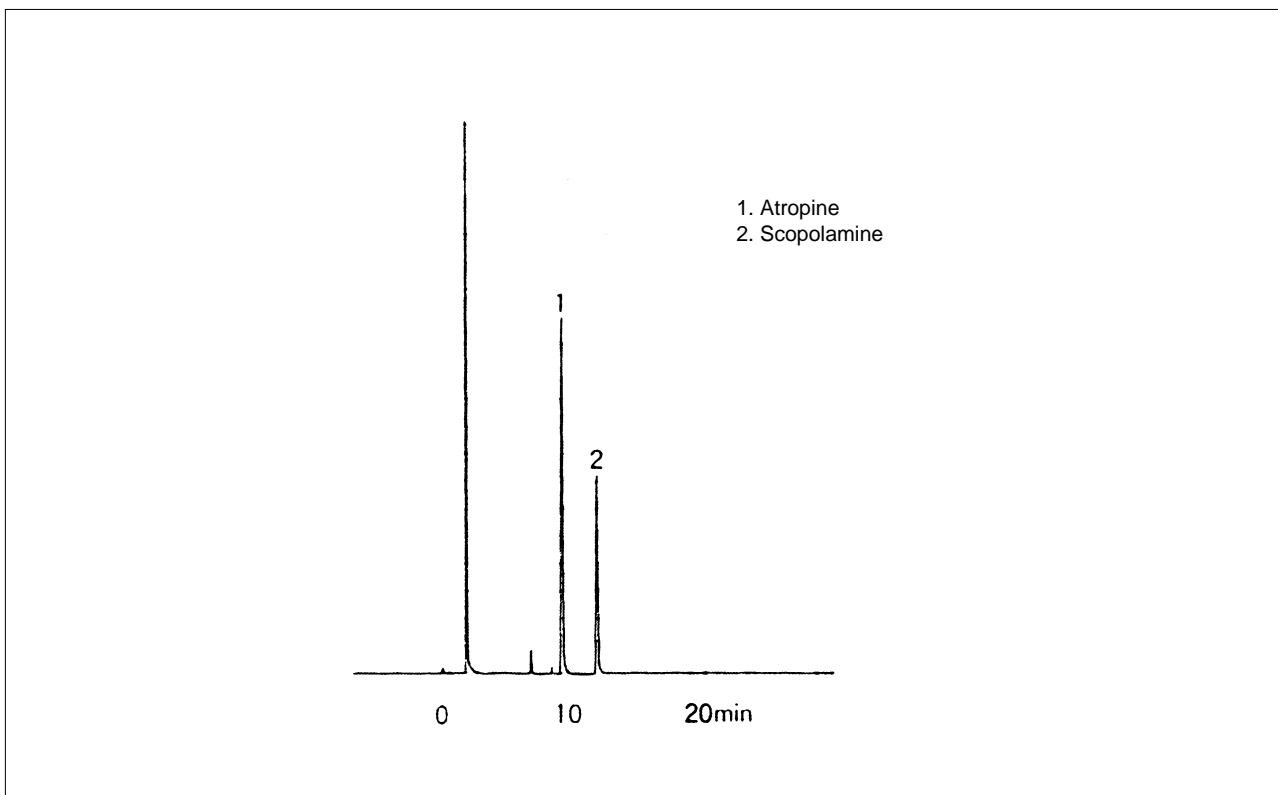

Fig. 1.2.2 Chromatogram of antispasmodic drug



1.3 Analysis of Sedative Sleeping Drug and Intravenously Injected Anesthetic - GC

•Explanation

This data introduces direct analysis of a sedative sleeping drug and intravenously injected anesthetic without derivatization.

•Pretreatment

Sedative sleeping drug and intravenously injected anesthetic are dissolved in methanol, and 1 μ L of this solution is injected.

•Analytical Conditions

Instrument	: GC-14BPFsc
Column	: (DB-1 30m \times 0.25mm i.d.) df=0.25 μ m
Col.Temp.	: 210 $^{\circ}$ C
Inj.Temp.	: 300 $^{\circ}$ C
Det.Temp.	: 300 $^{\circ}$ C (FID)
Carrier Gas	: He 0.5mL/min
Injection	: Split 1 : 100

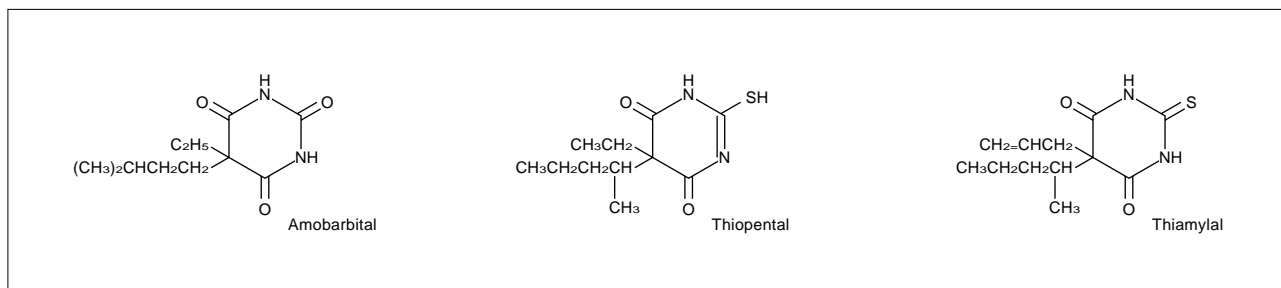

Fig. 1.3.1 Structural formula of Amobarbital, Thiopental and Thiamylal

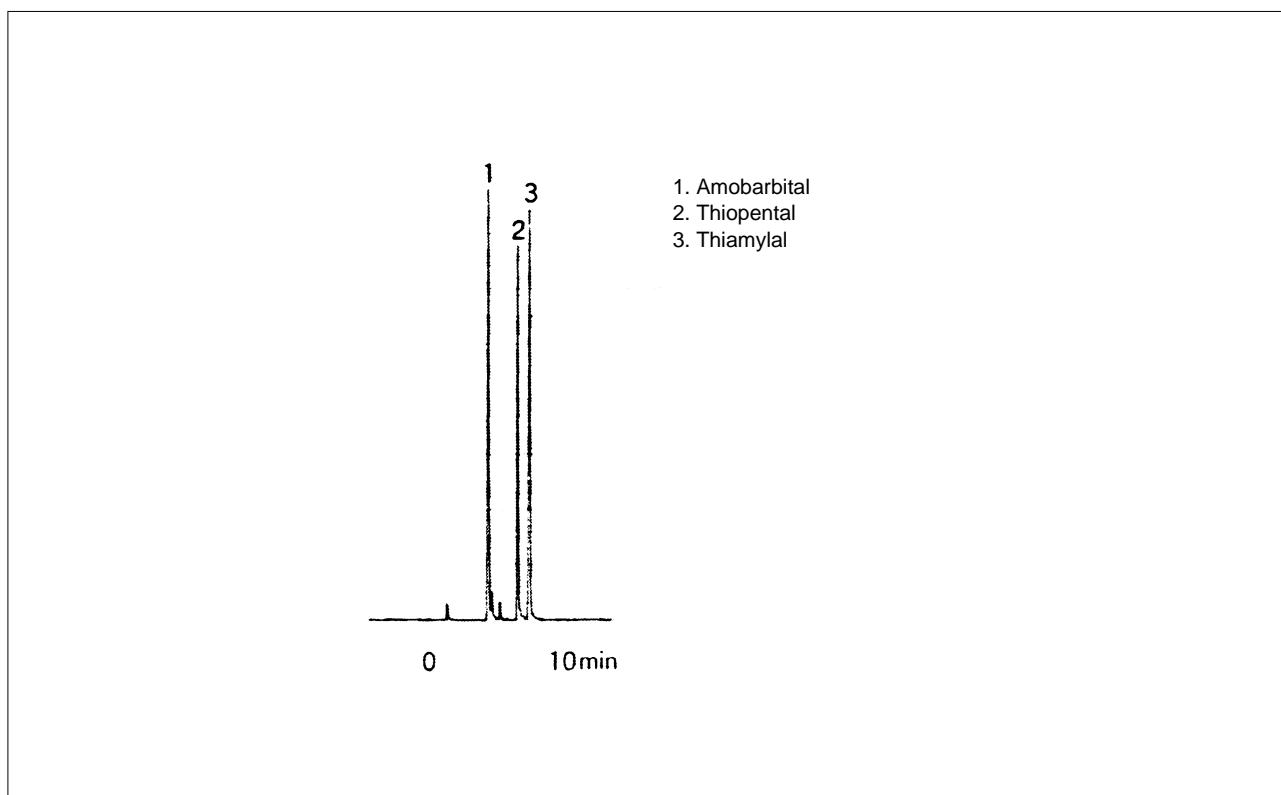

Fig. 1.3.2 Sedative sleeping drug and intravenously injected anesthetic

1.4 Analysis of Cold Medicine - GC

•Explanation

This data introduces direct analysis of a cold medicine without derivatization.

•Pretreatment

Cold medicine is dissolved in of methanol, and 1 μ L of this solution is injected.

•Analytical Conditions

Instrument	: GC-14BPFsc
Column	: (DB-1 30m \times 0.25mm i.d.) df=0.25 μ m
Col.Temp.	: 250 $^{\circ}$ C
Inj.Temp.	: 300 $^{\circ}$ C
Det.Temp.	: 300 $^{\circ}$ C (FID)
Carrier Gas	: He 0.5mL/min
Injection	: Split 1 : 100

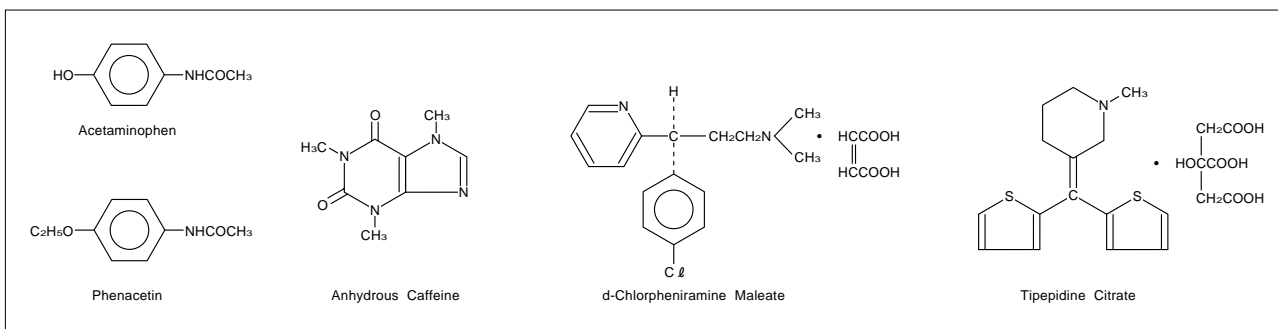

Fig. 1.4.1 Structural formula of Acetaminophen, Phenacetin, Anhydrous Caffeine, d-Chlorpheniramine Maleate and Titepidine Citrate

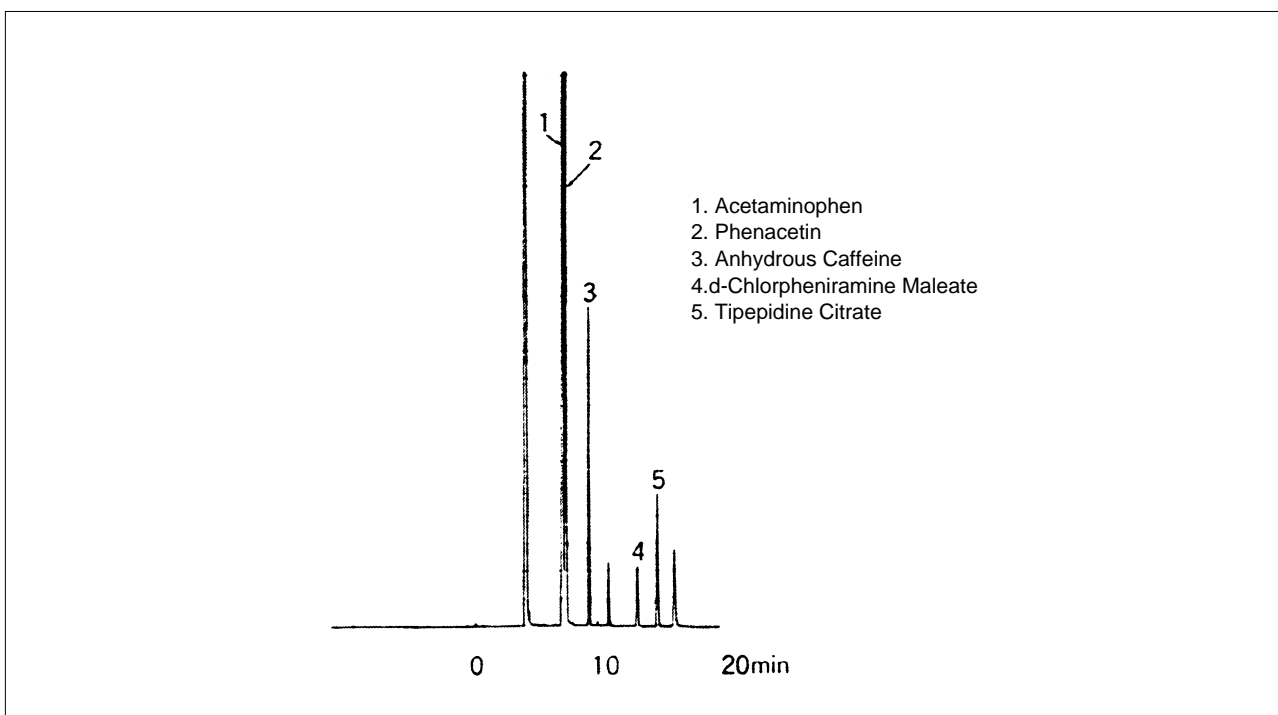

Fig. 1.4.2 Chromatogram of cold medicine



1.5 Analysis of Chlorpheniramine Maleate in Cold Medicine - GC

•Explanation

This is data concerning analysis of chlorpheniramine maleate using FID and FTD to see sensitivity comparisons.

•Pretreatment

See Fig. 1.5.1 for details.

•Analytical Conditions

Instrument : GC-14BPFsc
Column : DB-1 30m × 0.25mm i.d.
df=0.25µm
Col.Temp. : 70 °C (1min) — 8 °C/min — 260 °C
Inj.Temp. : 300 °C
Det.Temp. : 300 °C (FID, FTD)
Carrier Gas : He 4mL/min
Injection : Splitless (Sampling Time : 1min)

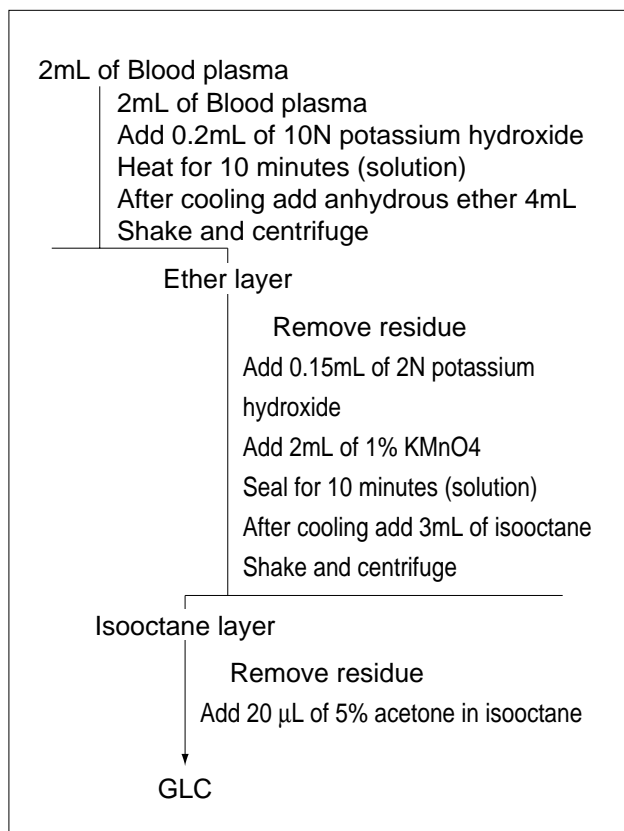

Fig. 1.5.1 Flowchart example of pretreatment in blood

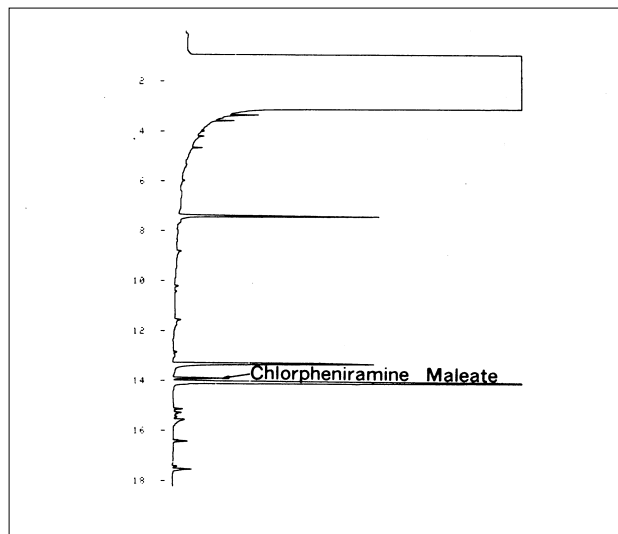

Fig. 1.5.2 Chromatogram of chlorpheniramine maleate in cold medicine using FID

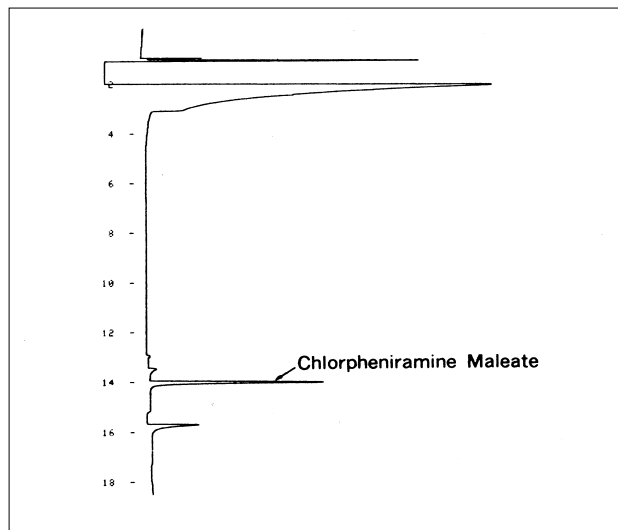

Fig. 1.5.3 Chromatogram of chlorpheniramine maleate in cold medicine using FTD

1.6 Headspace Analysis of Volatile Components in Pharmaceuticals and Non-Pharmaceutical Products (1) - GC

•Explanation

This data introduces analysis of two types of antiphlogistic pain relief ointment, two types of antiphlogistic pain relief plaster, lip cream and two types of toothpaste using the headspace gas chromatography method.

•Analytical Conditions

Instrument : GC-14BPFsc+HSS-2B
Column : ULBON HR-20M
25m × 0.32mm i.d. df=0.25µm
Col.Temp. : 200 °C
Inj.Temp. : 230 °C
Det.Temp. : 230 °C (FID)
Carrier Gas : He 1.2mL/min
Injection : Split 1 : 14
Sample Quantity : 20mg
Sample Thermostatting : 150 °C, 60min
Headspace Injection Volume : 0.8mL

•Pretreatment

The sample for analysis (pharmaceutical) is enclosed in a vial, is warmed for a set time at a constant temperature, and the headspace gas analyzed.

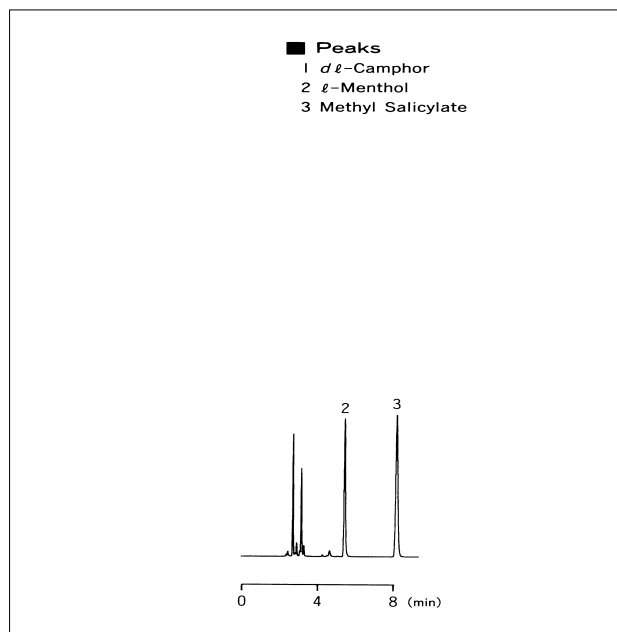

Fig. 1.6.1 Headspace gas chromatogram of antiphlogistic pain relief ointment A

•Analytical Conditions

Instrument : GC-14BPFsc+HSS-2B
Column : CBP20 25m × 0.53mm i.d.
df=1.0µm
Col.Temp. : 50 °C (5min) — 10 °C/min — 180 °C
Inj.Temp. : 220 °C
Det.Temp. : 220 °C (FID)
Carrier Gas : He 5.3mL/min
Injection : Split 1:4
Sample Quantity : 0.3g
Sample Thermostatting : 80 °C, 40min
Headspace Injection Volume : 0.8mL

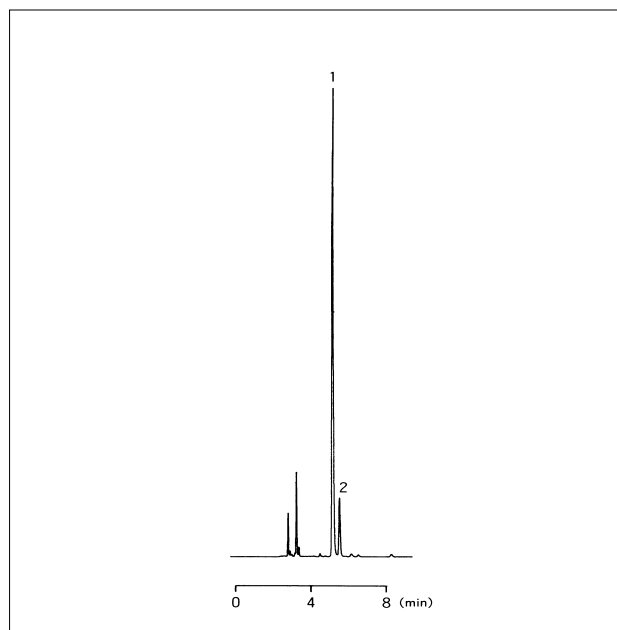

Fig. 1.6.2 Headspace gas chromatogram of antiphlogistic pain relief ointment B



1.6 Headspace Analysis of Volatile Components in Pharmaceuticals and Non-Pharmaceutical Products (2) - GC

•Analytical Conditions

Instrument : GC-14BPF_{sc}+HSS-2B
Column : CBP20 25m × 0.33mm i.d.
df=0.5μm
Col.Temp. : 70 °C — 10 °C/min — 200 °C
Inj.Temp. : 230 °C
Det.Temp. : 230 °C (FID)
Carrier Gas : He 1.5mL/min
Injection : Split 1 : 17
Sample Quantity : 2cm × 2cm
Sample Thermostatting : 60 °C, 20min
Headspace Injection Volume : 0.8mL

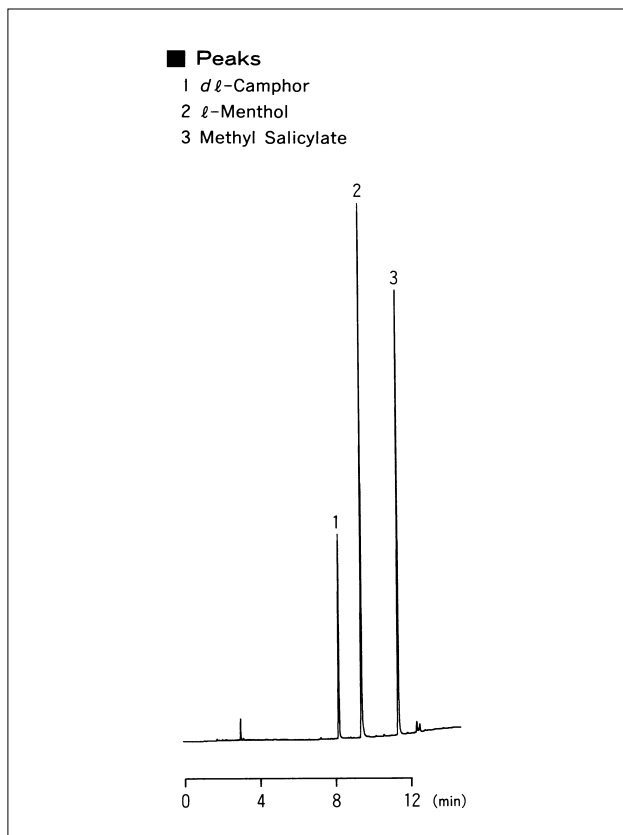

Fig. 1.6.3 Headspace gas chromatogram of antiphlogistic pain relief plaster (normal type)

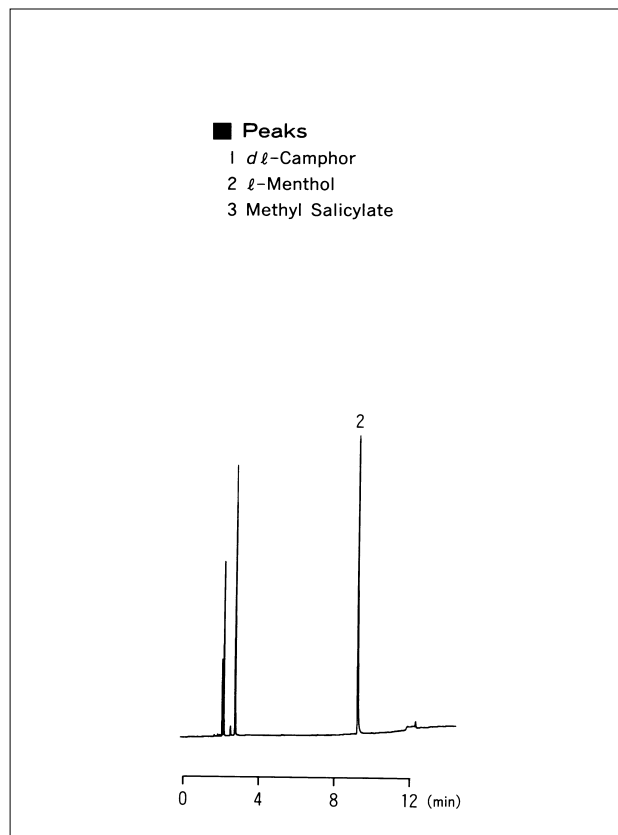

Fig. 1.6.4 Headspace gas chromatogram of antiphlogistic pain relief plaster (odorless type)

1.6 Headspace Analysis of Volatile Components in Pharmaceuticals and Non-Pharmaceutical Products (3) - GC

•Analytical Conditions

Instrument : GC-14BPF_{sc}+HSS-2B
 Column : ULBON HR-20M
 25m × 0.32mm i.d. df=0.25
 Col.Temp. : 200 °C
 Inj.Temp. : 230 °C
 Det.Temp. : 230 °C (FID)
 Carrier Gas : He 1.2mL/min
 Injection : Split1:14
 Sample Quantity : 20mg
 Sample Thermostatting : 150 °C, 60min
 Headspace Injection Volume : 0.8mL

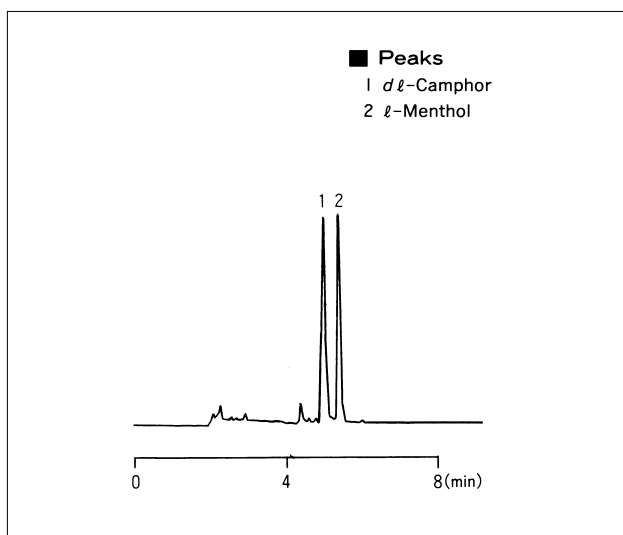

Fig. 1.6.5 Headspace gas chromatogram of lip cream

•Analytical Conditions

Instrument : GC-14BPF_{sc}+HSS-2B
 Column : CBP1 12m × 0.53mm i.d.
 df=1.0μm
 Col.Temp. : 60 °C — 10 °C/min — 200 °C
 Inj.Temp. : 200 °C
 Det.Temp. : 200 °C (FID)
 Carrier Gas : He 15mL/min
 Injection : Direct
 Sample Quantity : 0.5g
 Sample Thermostatting : 80 °C, 30min
 Headspace Injection Volume : 0.4mL

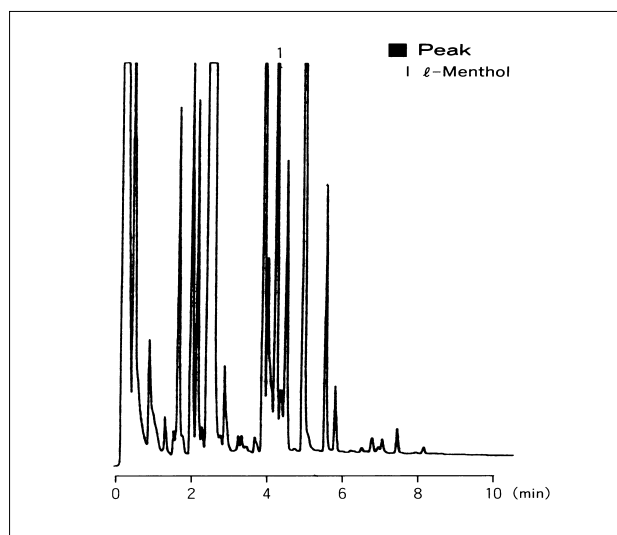

Fig. 1.6.6 Headspace gas chromatogram of toothpaste A

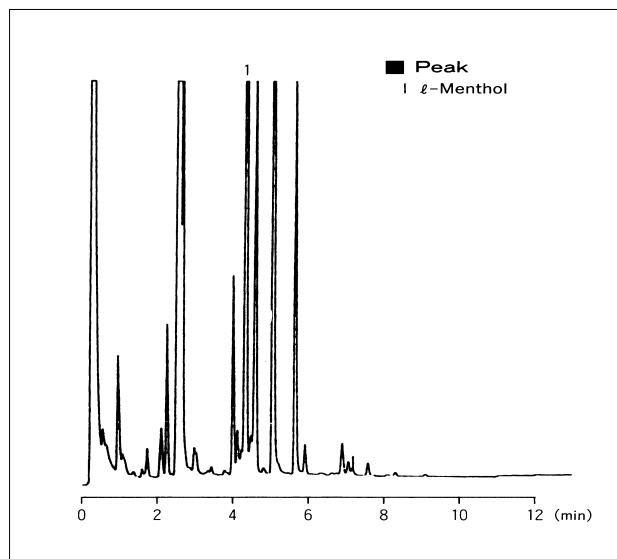

Fig. 1.6.7 Headspace gas chromatogram of toothpaste B



1.7 Analysis of Pharmaceuticals Using Direct Sample Inlet Method, EI, CI and Mass Spectrometry (1) - GCMS

•Explanation

Composite samples are difficult to analyze with MS using direct inlet (DI) because GC separation is not used, but direct inlet MS is effective in analysis of compounds easily heat decomposed or compounds with high boiling points. If the compound has been purified in advance, the structure can be confirmed quickly without having to make a derivative of it.

The structure and molecular weight of such a compound can be confirmed using a combination of electron-impact ionization (EI) and chemical ionization (CI) methods.

Maleic acid ergometrine is maleate of ergometrine. As shown in Fig. 1.7.7 to 1.7.9 and Fig. 1.7.10 to 1.7.12, the salt is decomposed by heating, ergometrine and maleic acid appear, and can be separated for observation using the differences in boiling points after decomposition.

•Analytical Conditions

Instrument	:GCMS-QP5050A (with CI/DI)
— MS —	
Interface Temp.	:250 °C
Ionization Method	:EI/CI (reaction gas: isobutane)
Scan Range	:m/z 35-700 (EI) m/z 100-700 (CI)
Scan Interval	:2sec
DI Temp.	:Room temperature - 10°C/min-350°C (10 min) (sample 1, 2, 3) Room temperature - 20°C/min-350°C (10 min) (sample 3 and 4)

Chart 1.7.1 Sample List

No.	Pharmaceuticals	Molecular Weight	Application
1	Japanese Pharmacopoeia standard product Prednisolone	360	Adrenocorticotrophic hormone action for full and local use
2	Japanese Pharmacopoeia standard product Reserpine	608	Antipsychotic agents, antihypertensives, sympathetic neuron blockers
3	Japanese Pharmacopoeia standard product Maleic acid ergometrine	441	Uterotonics, hemostatic drugs
4	Commercially available Indomethacin externally applied medicine	357	Antipyretic painkiller, antiphlogistic drugs

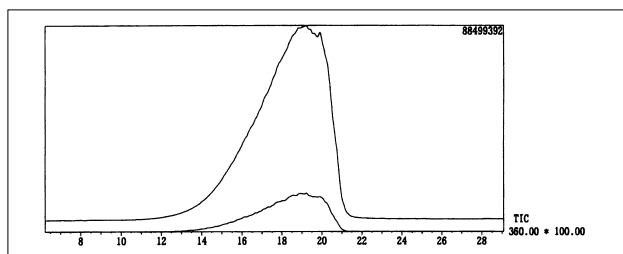

Fig. 1.7.1 Total ion chromatogram of prednisolone

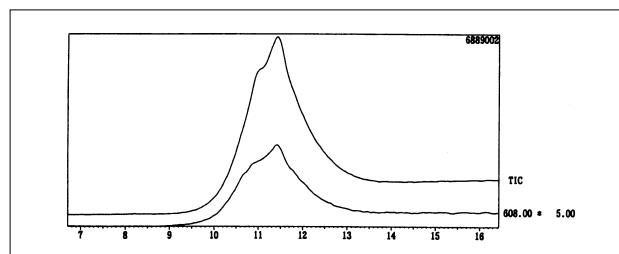

Fig. 1.7.4 Total ion chromatogram of reserpine

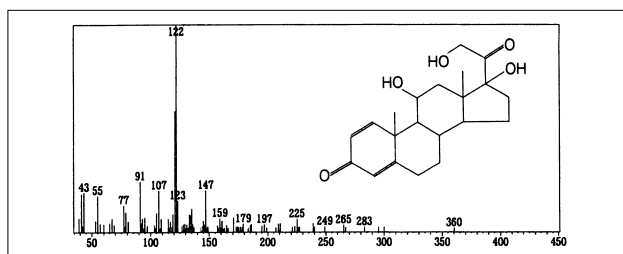

Fig. 1.7.2 EI mass spectrum of prednisolone

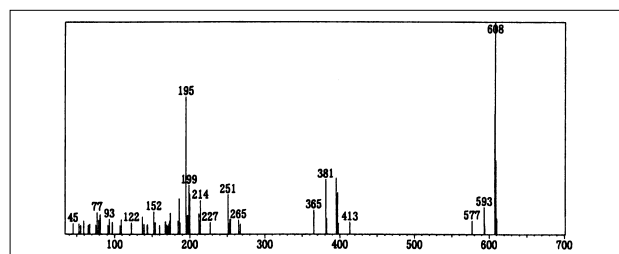

Fig. 1.7.5 EI mass spectrum of reserpine

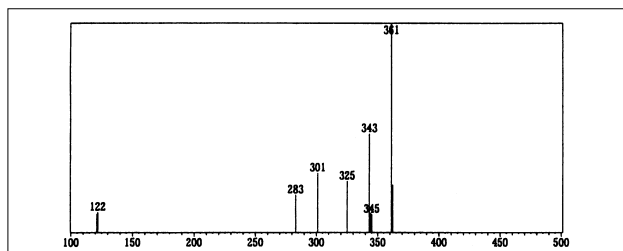

Fig. 1.7.3 CI mass spectrum of prednisolone

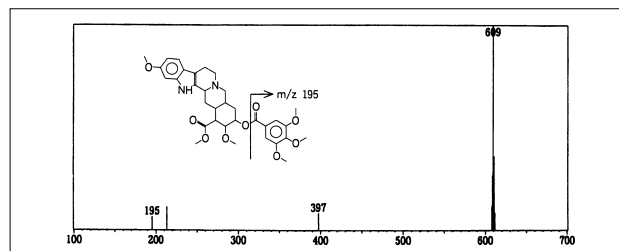

Fig. 1.7.6 CI mass spectrum of reserpine

1.7 Analysis of Pharmaceuticals Using Direct Sample Inlet Method, EI, CI and Mass Spectrometry (2) - GCMS

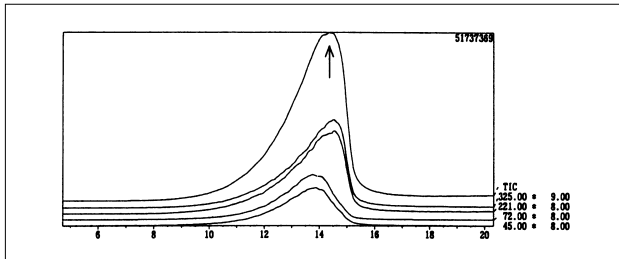

Fig. 1.7.7 Total ion chromatogram of maleic acid ergometrine using EI

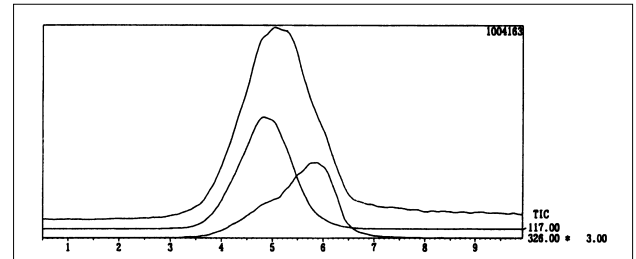

Fig. 1.7.10 Total ion chromatogram of maleic acid ergometrine using CI

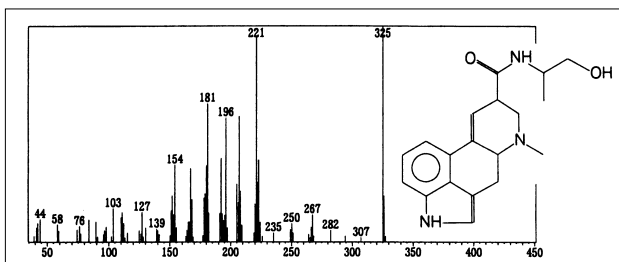

Fig. 1.7.8 EI mass spectrum of ergometrine

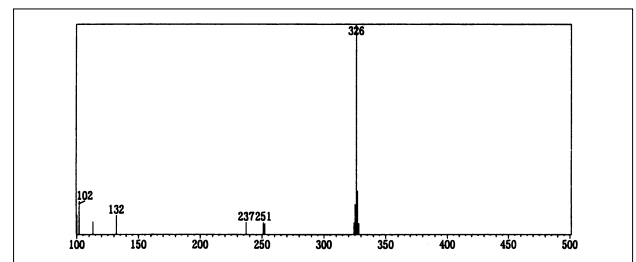

Fig. 1.7.11 CI mass spectrum of ergometrine

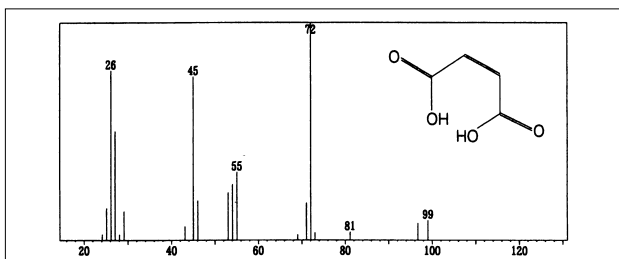

Fig. 1.7.9 EI mass spectrum of maleic acid

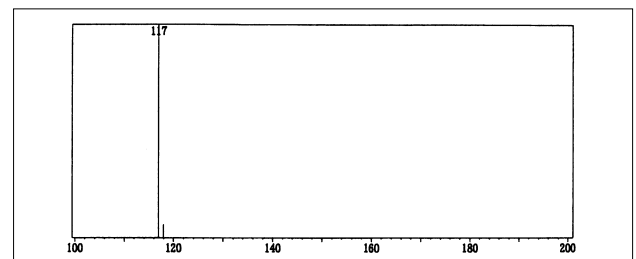

Fig. 1.7.12 CI mass spectrum of maleic acid

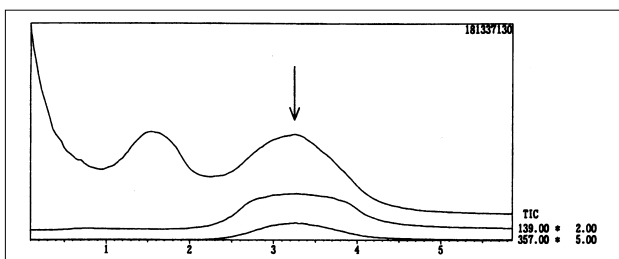

Fig. 1.7.13 Total ion chromatogram of indomethacin externally applied medicine

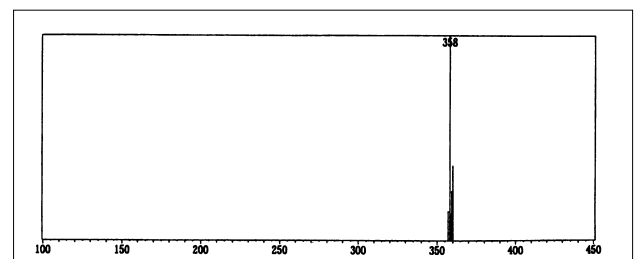

Fig. 1.7.15 CI mass spectrum of indomethacin

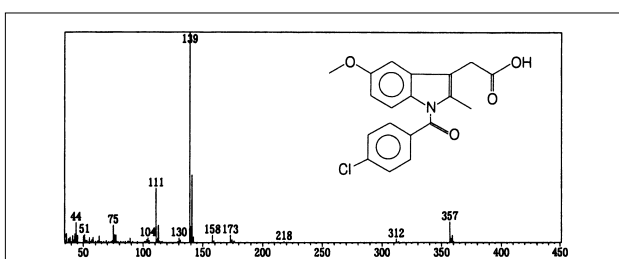

Fig. 1.7.14 EI mass spectrum of indomethacin



1.8 Analysis of Pharmaceutical (Acetate Ester of Vitamin E) Using a Mass Spectrometer - GCMS

•Explanation

Acetate ester of vitamin E (DL- α -tocopherol acetate) is used in prevention and treatment of vitamin E deficiency as well as being effective for peripheral vascular disturbance.

A commercially available cream with methylsiloxane base was dissolved in methanol and the contained acetate ester of vitamin E acetate confirmed.

•Analytical Conditions

Instrument : GCMS-QP5050A

— GC —

Column : DB-5 (30m \times 0.25mm i.d. df=0.1 μ m)

Column Temp. : 100°C (2min) — 10°C/min — 300°C

— MS —

Interface Temp. : 280°C

Ionization Method : EI

Scan Range : m/z 35-900

Scan Interval : 0.5sec

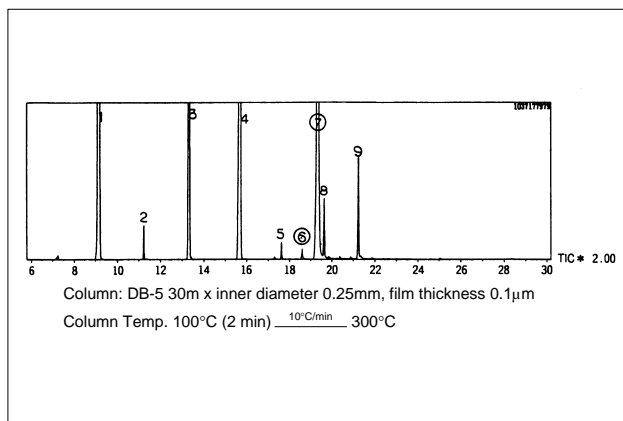

Fig. 1.8.1 Total ion chromatogram of cream

Chart 1.8.1 Qualitative results for cream

No.	Molecular Weight	Chemical Formula	Si	O	-CH ₃	-C ₆ H ₅
1	360	C ₁₈ H ₂₈ O ₂ Si ₃	3	2	6	2
2	582	C ₂₄ H ₄₆ O ₅ Si ₆	6	5	12	2
3	570	C ₂₇ H ₄₂ O ₄ Si ₅	5	4	9	3
4	558	C ₃₀ H ₃₈ O ₃ Si ₄	4	3	6	4
5	780	C ₃₆ H ₅₆ O ₆ Si ₇	7	6	12	4
8	768	C ₃₉ H ₅₂ O ₅ Si ₆	6	5	9	5
9	756	C ₄₂ H ₄₈ O ₄ Si ₅	5	4	6	6
No.	Molecular Weight	Chemical Formula	Compound Name			
⑥	472	C ₃₁ H ₅₂ O ₃	Vitamin E acetate (α -tocopherol acetate)			
⑦	584	C ₃₄ H ₆₄ O ₇	Docosanoic acid triethyl citrate			

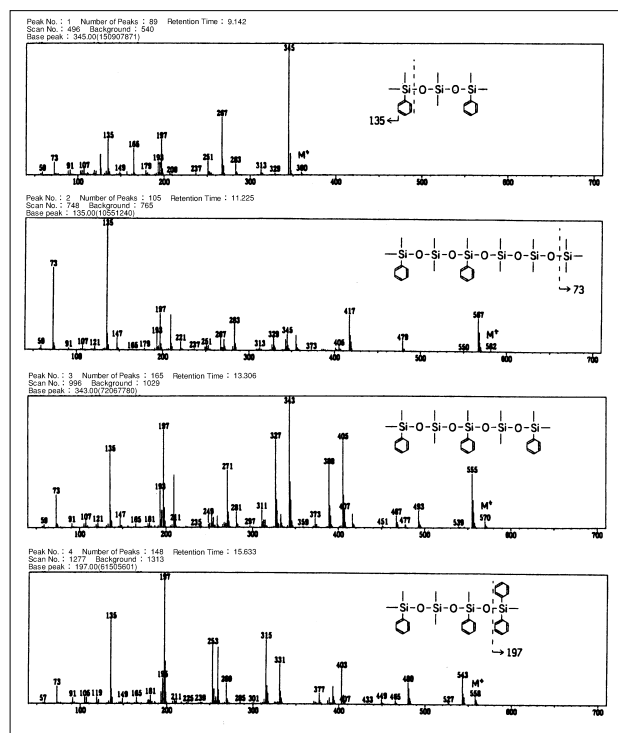

Fig. 1.8.2 Mass spectrums of peaks 1 to 4

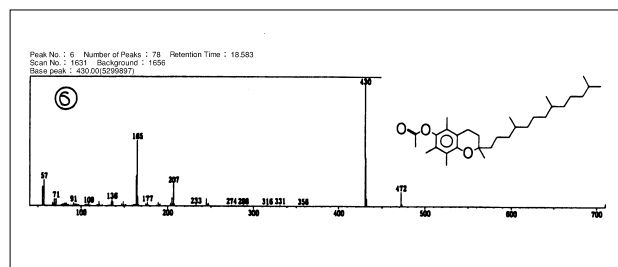

Fig. 1.8.3 Mass spectrums of peak (6)

1.9 Analysis of Cosmetics (1) - LC

The cosmetics we use daily contain a variety of elements, and these are strictly controlled to maintain their level of quality. This data introduces some analysis examples

including pretreatment of effective elements contained in regularly used cosmetics: two types of hair lotion, medicated treatment cream and medicated shampoo.

◆ Analysis of Glycyrrhizic Acid and Piroctone in Shampoo

● Explanation

This data gives an analysis example for glycyrrhizic acid and piroctone in commercially available shampoo. It is recommended that the flow route and syringe, etc., be washed in advance with EDTA-2Na (ethylenediamine tetraacetic acid - 2-sodium) and the greatest care be taken to prevent as best as possible the effects of metal such as contamination that occurs with separation in order to suppress peak shape turbulence due to the metal coordination of piroctone.

● Pretreatment

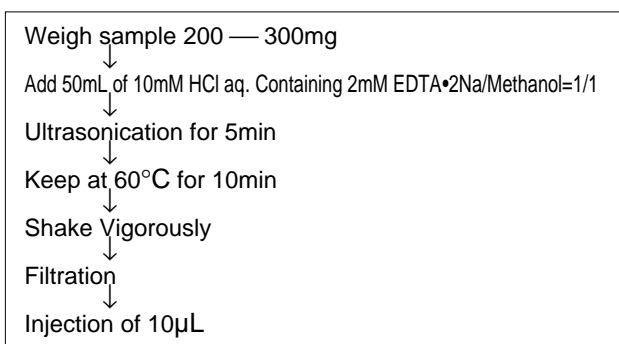

● Analytical Conditions

Instrument : HPLC
 For Separation
 Column : L-Column ODS
 (150mmL × 4.6mm i.d.)
 Mobile Phase : Gradient Program A→B
 A : 10mM (Sodium) Phosphate (pH2.6)
 Containing 0.1mM EDTA•2Na
 /Acetonitrile = 4/1
 B : 10mM (Sodium) Phosphate (pH2.6)
 Containing 0.2mM EDTA•2Na
 /Acetonitrile = 1/3
 Flow Rate : 1.0mL/min
 Temperature : 40°C
 Detection : UV-VIS Detector 250nm
 Atten 7 (change to 8 at 6min)

Time Program	#	TIME	FUNC	VALUE
	0	3.00	B.CONC	40.0
	1	6.00	WAVE A	300
	2	10.00	B.CONC	100.0
	3	15.00	B.CONC	100.0
	4	15.01	B.CONC	40.0
	5	20.90	WAVE A	250
	6	21.00	ZERO A	
	7	22.00	STOP	

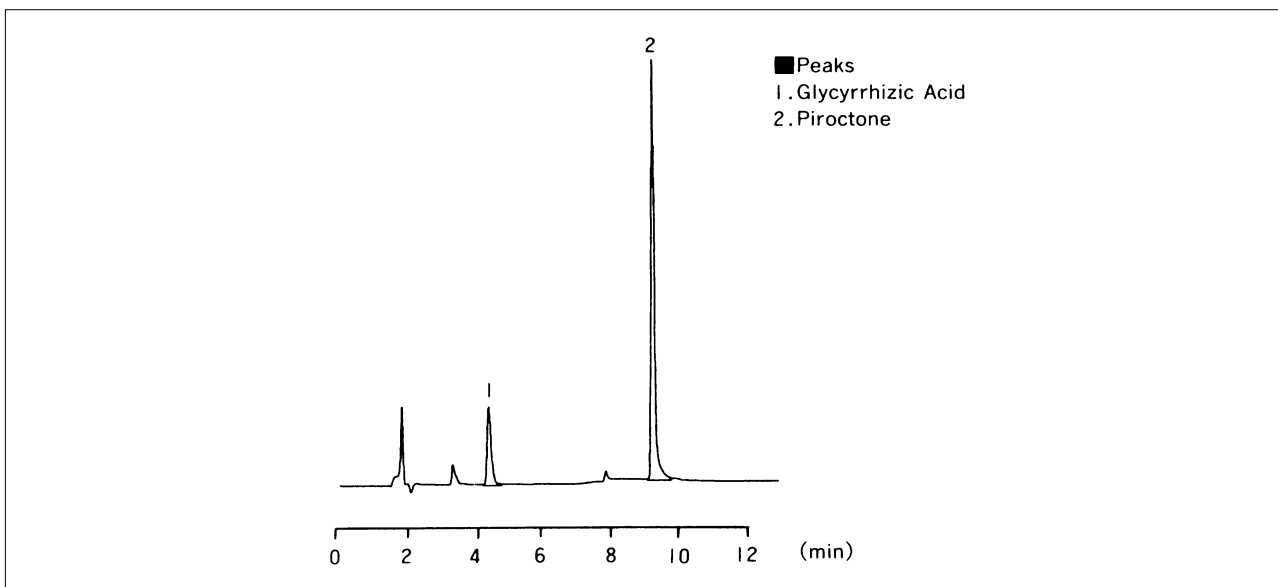

Fig. 1.9.1 Analysis of commercially available shampoo



1.9 Analysis of Cosmetics (2) - LC

◆ Analysis of Allantoin in Treatment Cream used as Medicine

● Pretreatment

Weigh sample 200 — 300mg



Add 50mL of Water



Ultrasonication for 5min



Keep at 60°C for 10min



Shake Vigorously



Filtration



Injection of 10/μL

● Analytical Conditions

Instrument : HPLC

Column : Asahipak NH2P-50
: (250mmL × 4.6mm i.d.)

Mobile Phase : 10mM (Sodium) Phosphate (pH2.6)/
Acetonitrile =1/4

Flow rate : 1.0mL/min

Temperature: 40 °C

Detection : UV-VIS Detector 200nm

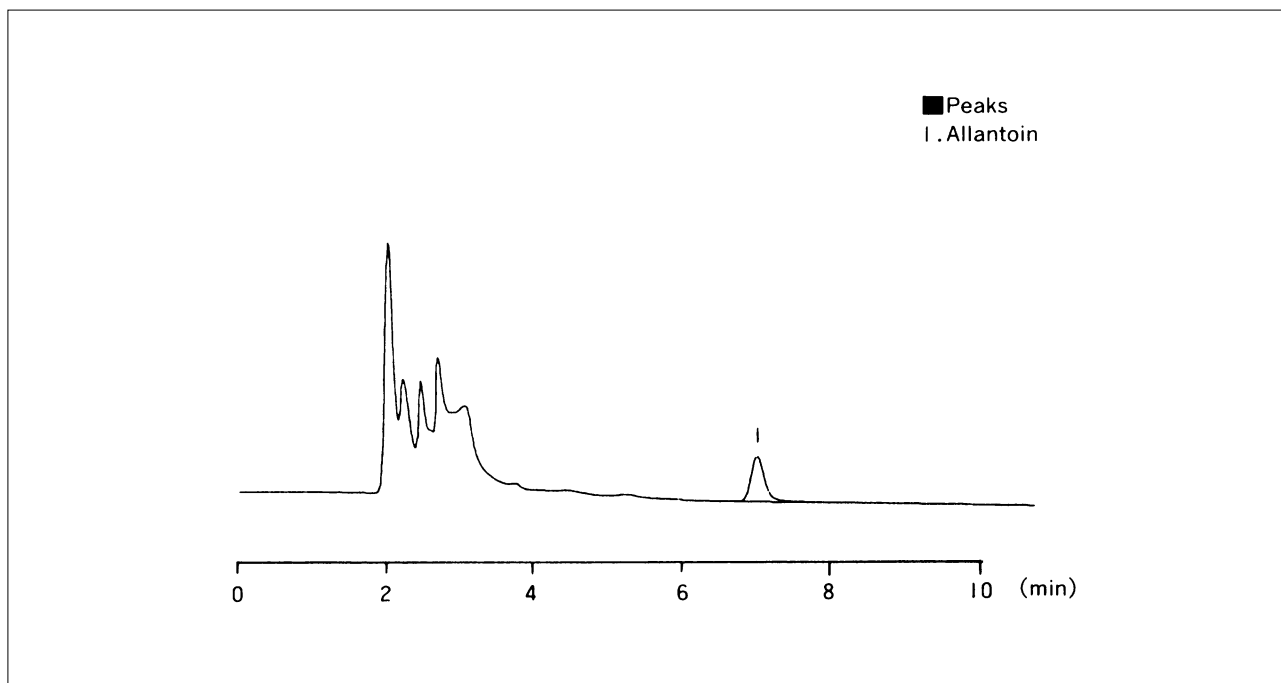

Fig. 1.9.2 Analysis of Allantoin

1.9 Analysis of Cosmetics (3) - LC

◆ Analysis of Hair Lotion

● Explanation

This data introduces analysis examples of two types of hair lotion (A and B). The same care needs to be taken for lotion A as previously explained for piroctone because it

● Pretreatment

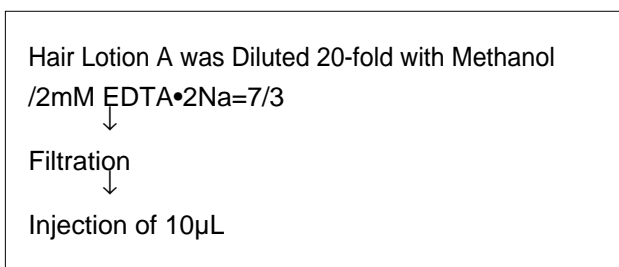

● Analytical Conditions

Instrument : HPLC
 Column : L-Column ODS (150mmL \times 4.6mm i.d.)
 Mobile Phase : Gradient Program A \rightarrow B
 A : 10mM (Sodium) Phosphate (pH2.6)
 Containing 0.1mM EDTA•2Na
 /Acetonitrile = 6/1
 B : 10mM (Sodium) Phosphate (pH2.6)
 Containing 0.2mM EDTA•2Na
 /Acetonitrile = 1/3
 Flow Rate : 1.0mL/min
 Temperature : 40°C
 Detection : UV-VIS Detector 275nm

Time Program	#	TIME	FUNC	VALUE
	0	2.00	B.CONC	0.0
	1	6.00	WAVE A	400
	2	10.00	B.CONC	100.0
	3	11.50	WAVE A	260
	4	16.00	B.CONC	100.0
	5	16.01	B.CONC	0.0
	6	20.80	WAVE A	275
	7	21.00	ZERO A	
	8	22.00	STOP	

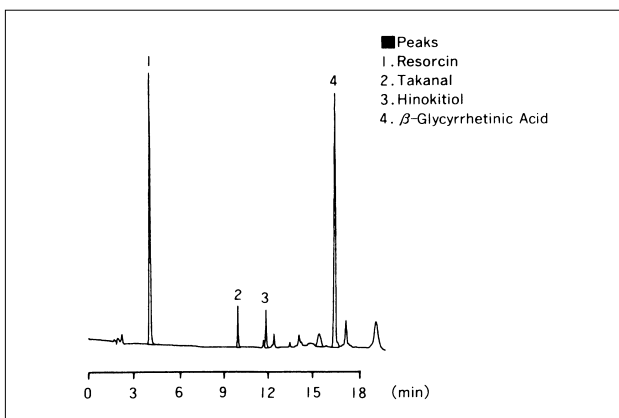
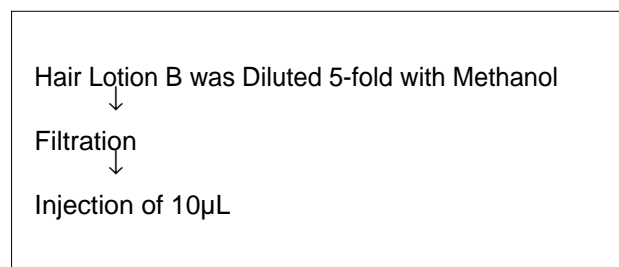

Fig. 1.9.3 Analysis of hair lotion A

contains hinokitiol, which causes metal coordination. Swertiamarin in lotion B is the effective element in senburi, a Japanese herbal plant.

● Pretreatment



● Analytical Conditions

Instrument : HPLC
 Column : L-Column ODS (150mmL \times 4.6mm i.d.)
 Mobile Phase : Gradient Program A95% \rightarrow B70%
 A : 10mM (Sodium) Phosphate (pH2.6)
 Containing 100mM
 NaClO₄/Acetonitrile = 10/1
 B : 10mM (Sodium) Phosphate (pH2.6)
 Containing 100mM
 NaClO₄/Acetonitrile = 1/1
 Flow Rate : 1.0mL/min
 Temperature : 40°C
 Detection : UV-VIS Detector 240nm

Time Program	#	TIME	FUNC	VALUE
	0	4.90	B.CONC	5.0
	1	5.00	B.CONC	70.0
	2	7.00	WAVE A	220
	3	14.50	WAVE A	370
	4	16.00	B.CONC	70.0
	5	16.10	B.CONC	5.0
	6	20.40	WAVE A	240
	7	21.50	ZERO A	
	8	22.00	STOP	

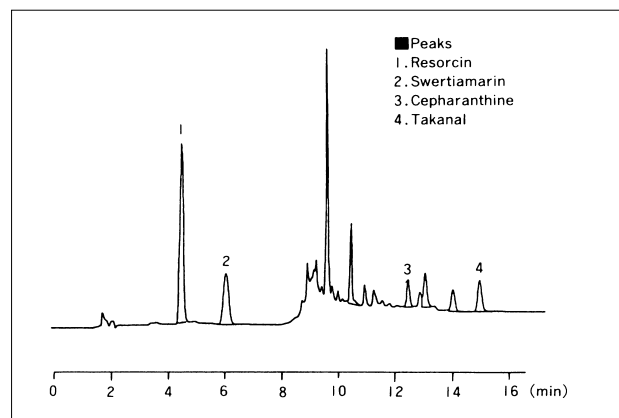

Fig. 1.9.4 Analysis of hair lotion B



1.10 Analysis of Hair Lotions (1) - LC

Hair lotions provide the scalp with a cooling sensation, stimulate the scalp, are effective in stopping unpleasant itchiness, enhance scalp blood circulation and aid the activation of hair root cells. Also such tonics function as a

fragrance in combination with a germ-killing effect to protect the scalp and hair from microbes such as bacteria. Here, this data introduces an example of analysis on effective elements contained in a hair lotion.

◆Analysis of Hinokitiol

●Explanation

Hinokitiol is well known as an element contained in the Japanese cypress tree (hinoki) that has a germ-killing effect. Fig. 1.10.1 shows an analysis example of the standard hinokitiol and Fig. 1.10.2 shows an analysis example hinokitiol contained in hair lotion. The hair lotion is diluted in methanol and injected for analysis.

●Analytical Conditions

Instrument : HPLC

Column : Asahipak ODP-50(150mmL. × 4.6mm i.d.)

Mobile Phase: A ; 10mM NaH₂PO₄ Solution
(adjusted to pH2.0 with H₃PO₄)

B ; Acetonitrile

A/B=1/1 (v/v)

Flow Rate : 0.5mL/min.

Temperature: 55°C

Detection : UV-VIS Detector 240nm

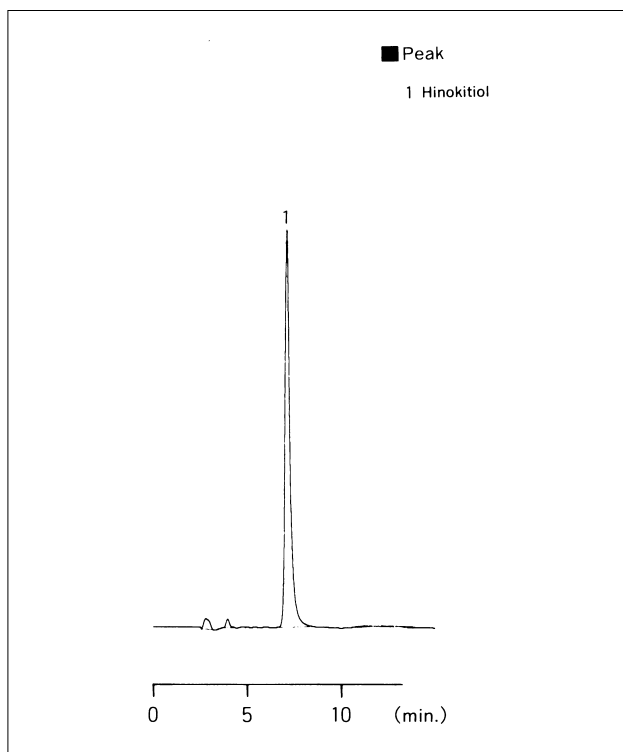

Fig. 1.10.1 Chromatogram of standard hinokitiol

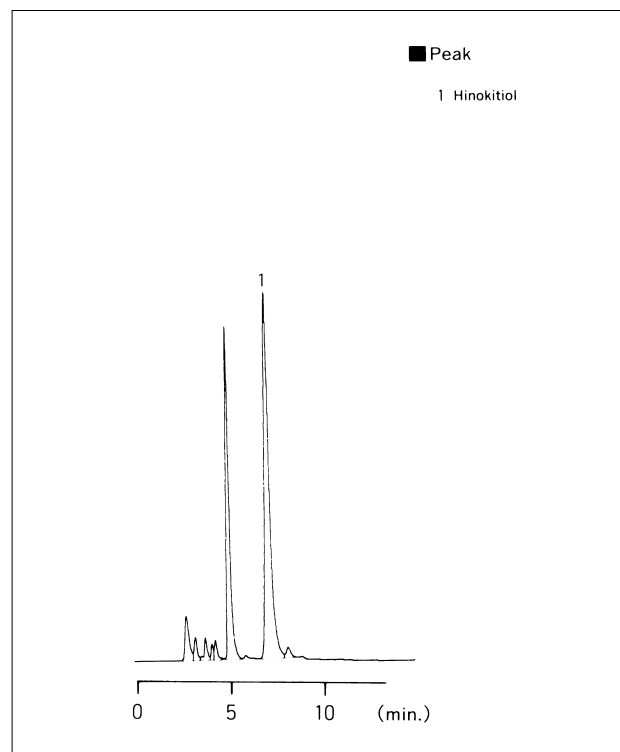

Fig. 1.10.2 Chromatogram of hair lotion A

1.10 Analysis of Hair Lotions (2) - LC

◆ Analysis of Resorcinol, D-Panthenol and Vitamin B₆

● Explanation

This data introduces analysis examples of resorcinol, D-panthenol and vitamin B₆ that are regarded as being effective for germ killing and the prevention of itchiness and hair loss. Fig. 1.10.3 shows a chromatogram of the standard products while Fig. 1.10.4 and Fig. 1.10.5 show chromatograms of hair lotions B and C. All samples were diluted in methanol and injected for analysis.

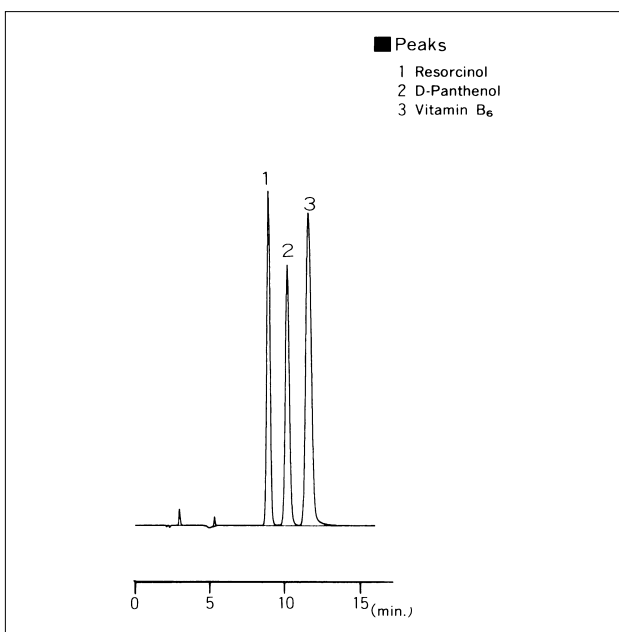

Fig. 1.10.3 Chromatogram of resorcinol, D-panthenol and vitamin B₆

● Analytical Conditions

Instrument : HPLC

Column : Shim-pack CLC-ODS (150mmL. × 6.0mm i.d.)

Mobile Phase : A ; 10mM Phosphate Buffer (pH2.6)

including 10mM (Sodium)

Pentane Sulfonate

B; Methanol

A/B=9/1 (v/v)

Flow Rate : 1.0mL/min

Temperature: 50°C

Detection : UV-VIS Detector 210nm

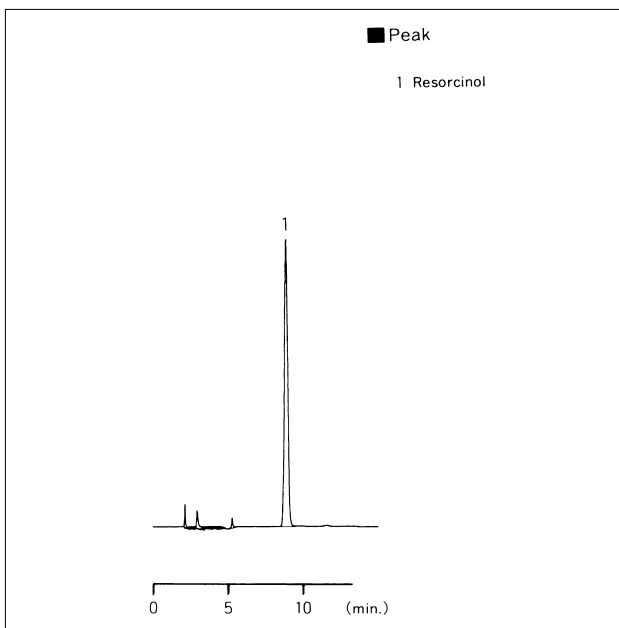

Fig. 1.10.4 Chromatogram of hair lotion B

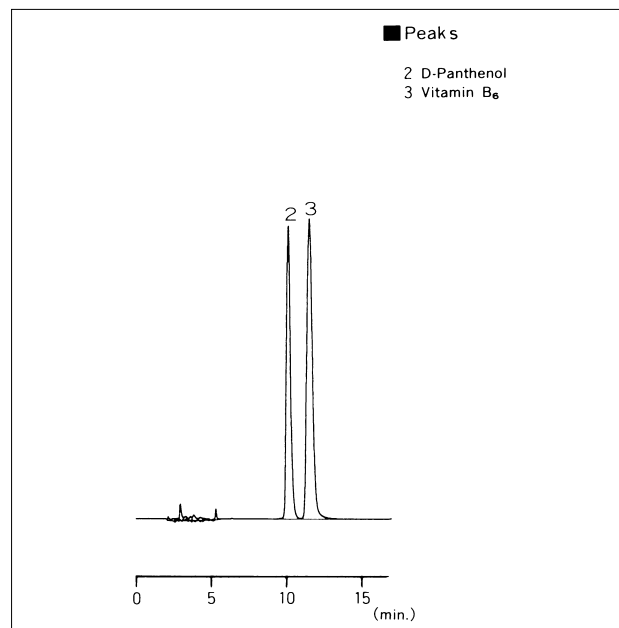

Fig. 1.10.5 Chromatogram of hair lotion C



1.11 Analysis of Synthetic Antibacterial Agents - LCMS

•Explanation

Synthetic anti-bacterial drugs are widely used as feed additives and pharmaceuticals for animals to improve production of livestock and marine products. However, in recent years, fears have been expressed about the shift to livestock and marine products produced with such drugs and the effects that such drug residues might have on humans. Liquid chromatography is used in analysis work on these synthetic anti-bacterial drugs. There are numerous target compounds in such analysis, and these need to be individually separated or separated into sample matrixes, while, moreover, the target compounds themselves also are difficult to identify. Consequently, there is a need for an analysis method with superior sensitivity that provides greater selectivity and abundant qualitative data.

Here, a LCMS-PDA-MS system with LCMS-QP8000 α (LabSolutions S/W) comprising a photodiode array detector was used to analyze 11 products including thiamphenicol (TPC), sulfadimidine (SDD), sulfamonomethoxine (SMM), sulfadimethoxine (SDM) and oxolinic acid (OXA) that are greatly used in the production of synthetic anti-bacterial drugs designated as feed additives and animal pharmaceuticals. Fig. 1.11.1 and Fig. 1.11.2 show data acquired from qualitative information (MS and UV spectrums) using SCAN measuring, while Fig. 1.11.3 shows the results of a standard additive test for pig liver extract. The pig liver extract fluid was prepared in adherence with the "acetonitrile-hexane distribution method" laid down in

the general analysis method for synthetic anti-bacterial drugs according to the official method (Ministry of Health and Welfare, Veterinary Sanitation Division Notification No. 78).

•Analytical Conditions

Instrument	: Shimadzu LCMS-QP8000 α
Column	: Shim - pack VP - ODS (2.0 mmI.D. \times 150 mmL)
Mobile phase A	: water containing 0.3% acetic acid
Mobile phase B	: 60% acetonitrile-water containing 0.3% acetic acid
Time program	: 0%B (0 min) \rightarrow 70%B (30 - 32 min)
Flow rate	: 0.2 mL/min
Injection volume	: 50 μ L
Temperature	: 40 $^{\circ}$ C
Ionization mode	: ESI (+)
Nebruaizing gas flow rate	: 4.5 L/min
Applied voltage	: 4.5kV CDL tempe.: 230 $^{\circ}$ C
CDL voltage	: -30V DEFs voltage: + 40 V
Scan range for SCAN analysis	: m/z 100 - 400 (0.8 sec/scan)
Monitor ions for SIM analysis	: m/z 291, 265, 356, 358, 249, 251, 279, 226, 281, 361, 311, 301(0.8 sec/12 chs)

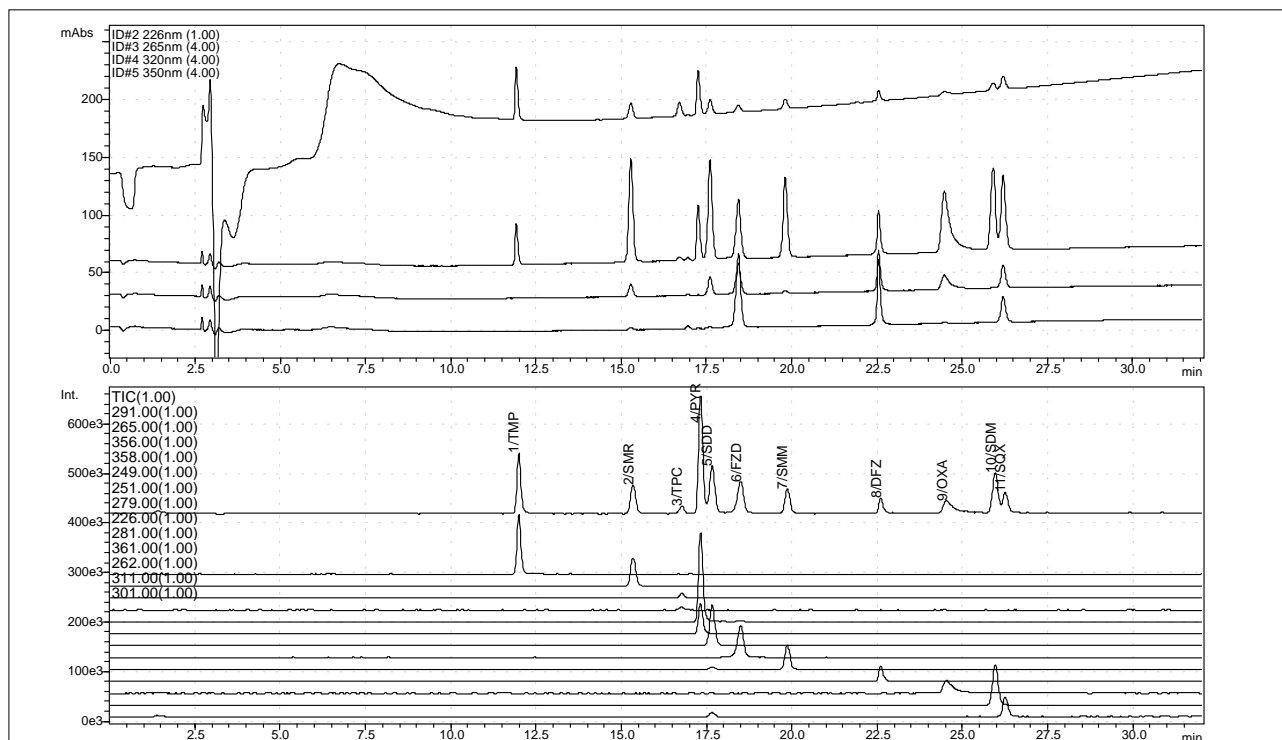

Fig. 1.11.1 Chromatogram of synthetic anti-bacterial standard product (400ppb)

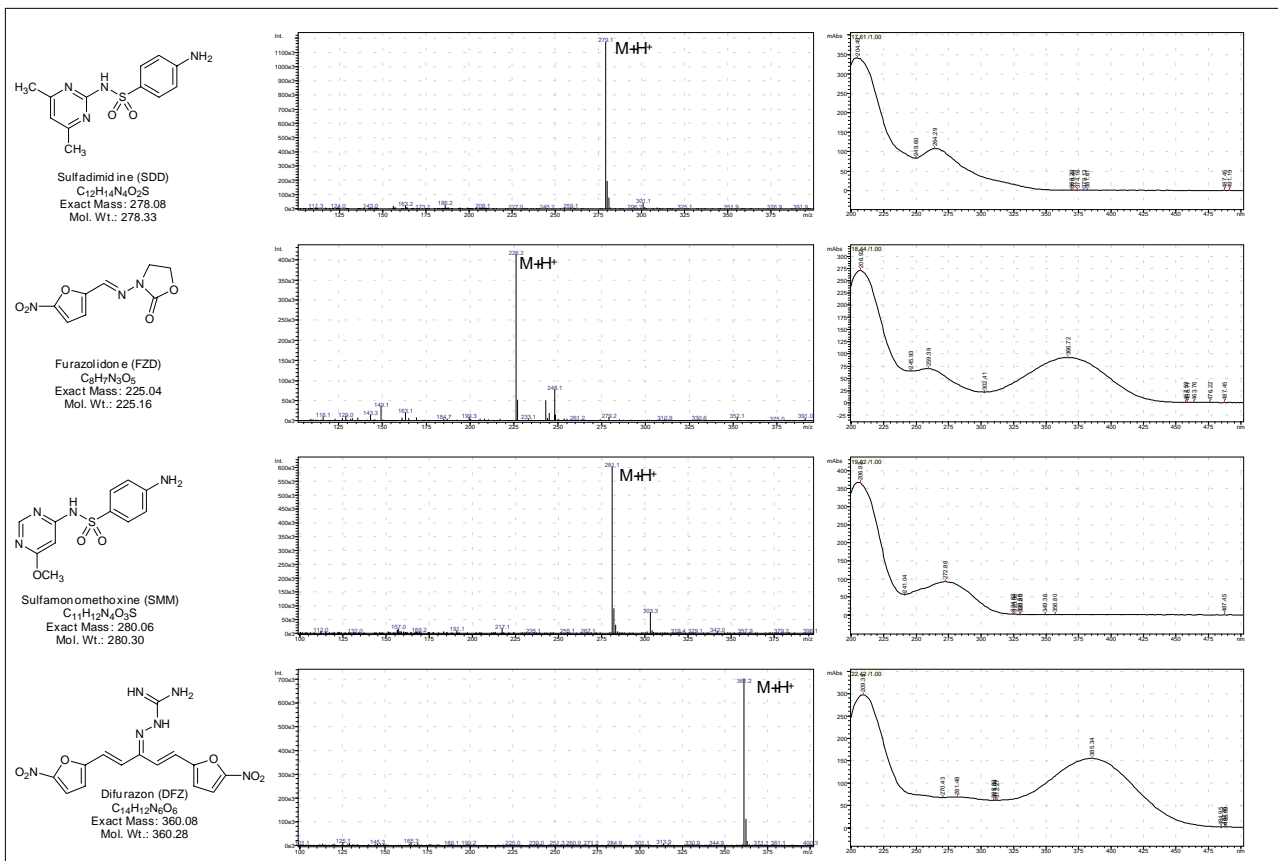

Fig. 1.11.2 Qualitative information (MS, UV) on synthetic anti-bacterial standard product

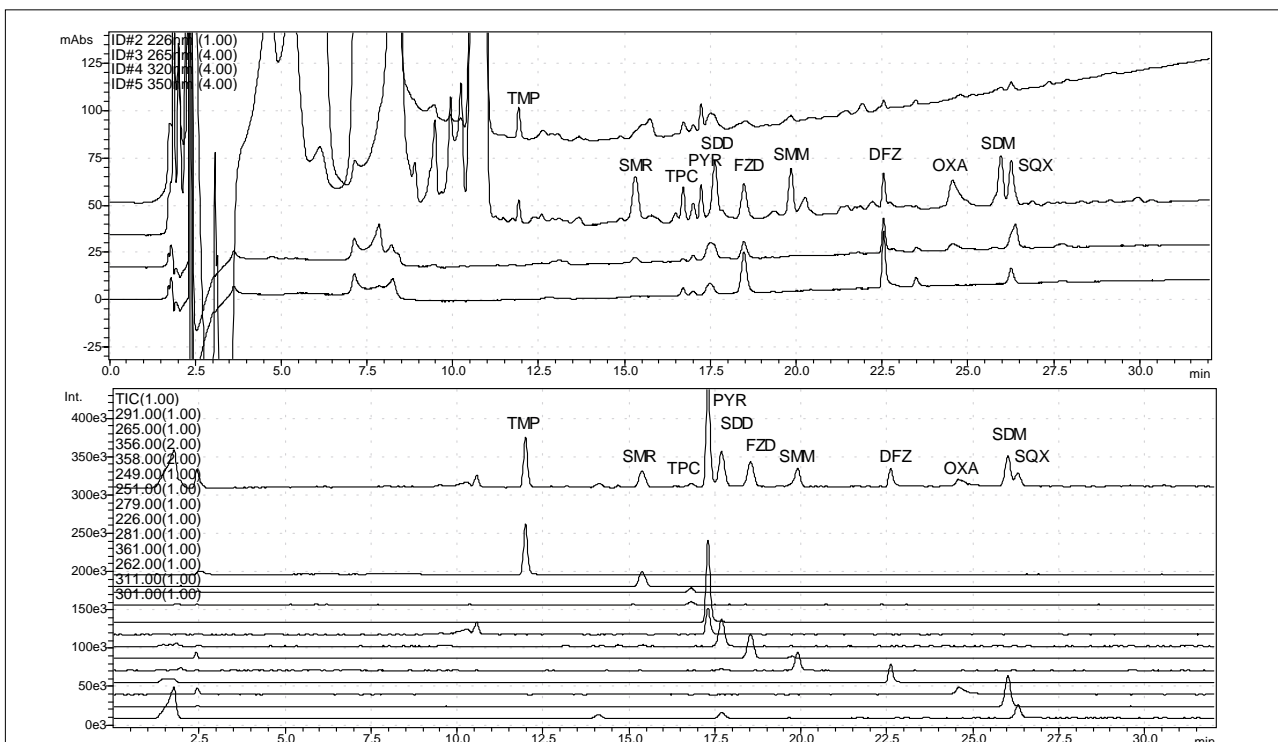

Fig. 1.11.3 Analysis results for pig liver extract liquid standard additive (200ppb)



2. Antibiotics

2.1 Analysis of Low-Volatile High-Mass Compound Using DI-MS - GCMS

•Explanation

Compounds that are difficult to vaporize must be made vaporizable with a derivation process to enable analysis by gas chromatograph or gas chromatograph mass spectrometer. However, slightly difficult-to-vaporize compounds can be measured using a direct sample introduction mass spectrometer (DI-MS). Here, even mixtures can be separated to some extent according to differences in boiling points.

Virginiamycin-M (Fig. 2.1.1) and virginiamycin-S (Fig. 2.1.2) are mixed into the commercially available antibiotic virginiamycin. Mass chromatograms of virginiamycin-M at m/z 507 (M-OH) and virginiamycin-S at m/z 823 (M^+) confirm that the two elements are mixed into the antibiotic (Fig. 2.1.3).

Fig. 2.1.4 is the mass spectrum of virginiamycin-M. The

DI temperature (probe temperature) is 181°C. Fig. 2.1.5 is the mass spectrum of virginiamycin-S. And the DI temperature (probe temperature) is 223°C.

•Analytical Conditions

Instrument : GCMS-QP1000 (with DI)
— MS —
Interface Temp. : 250°C
Ionization Method : EI
Scan Range : m/z 100-600
Scan Interval : 2sec
DI Temp. : Room Temp. -30°C/min-250°C
(10 min)

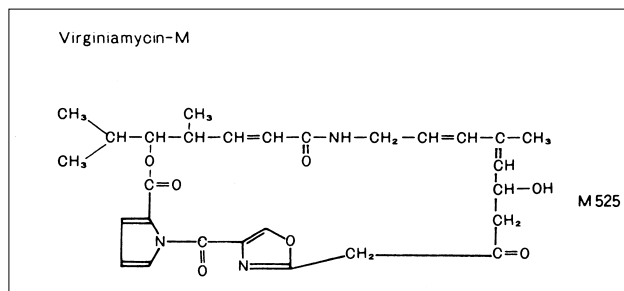

Fig. 2.1.1 Structure of virginiamycin-M

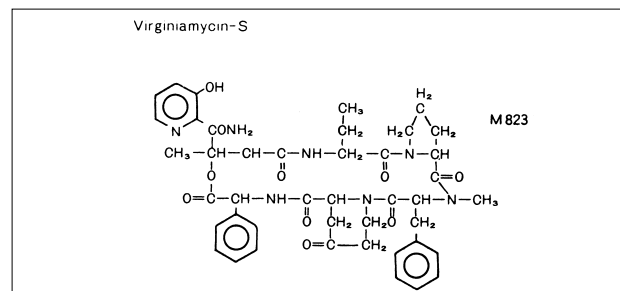

Fig. 2.1.2 Structure of virginiamycin-S

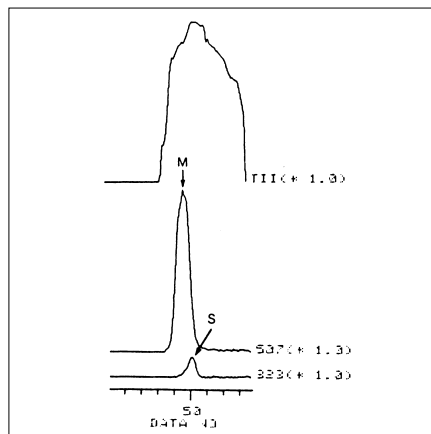

Fig. 2.1.3 Mass chromatogram of virginiamycin

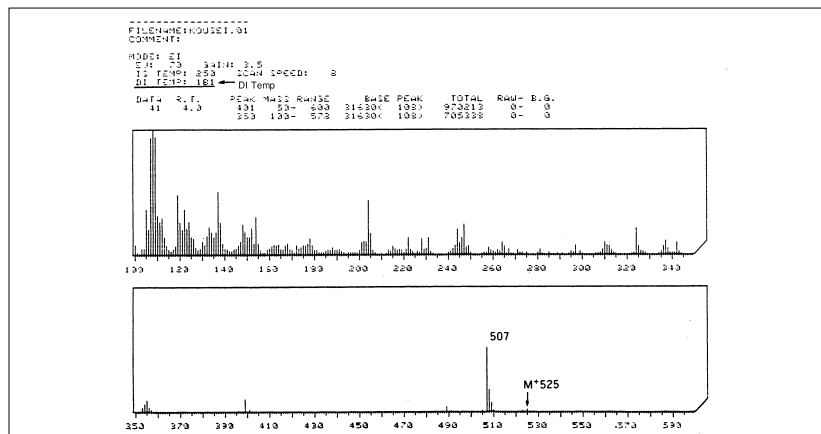

Fig. 2.1.4 Mass spectrum of virginiamycin-M

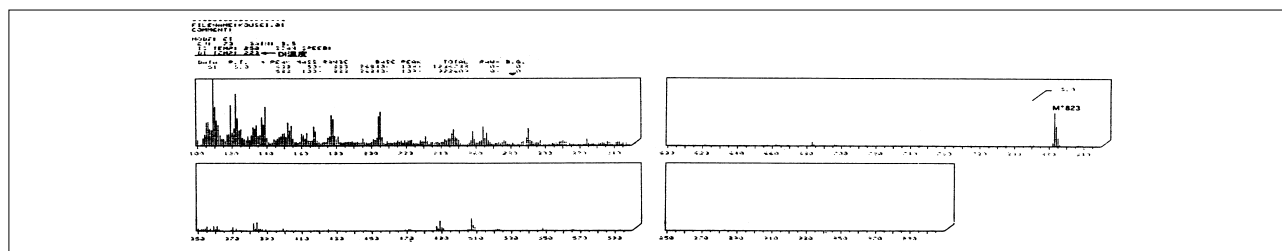

Fig. 2.1.5 Mass spectrum of virginiamycin-S

2.2 Analysis of Antibacterial Agents in Edible Meat - LC

Residual analysis of antibacterial agents is extremely important from the point of view of quality control of edible meat. These analyzes can be performed with

straightforward pretreatment. This data introduces analysis examples of the antibacterial agent sulfamethazine.

◆ Analysis of Sulfamethazine

● Explanation

Fig. 2.2.2 shows data for a 20 μ L injection of sulfamethazine standard solution (200ppb). Fig. 2.2.3 shows data for commercially available pork (150ppb of sulfamethazine added).

● Analytical Conditions

Instrument : HPLC
Column : Shim-pack CLC-ODS
(150mm L. \times 6.0mm i.d.)
Mobil Phase : 10mM Sodium Phosphate Buffer
(pH2.6)/Acetonitrile = 85/15
Column temp. : 40 $^{\circ}$ C
Flow rate : 1.0mL/min
Detection : UV-VIS Detector 250nm

● Pretreatment

Pretreatment of the sample is shown in Fig. 2.2.1.

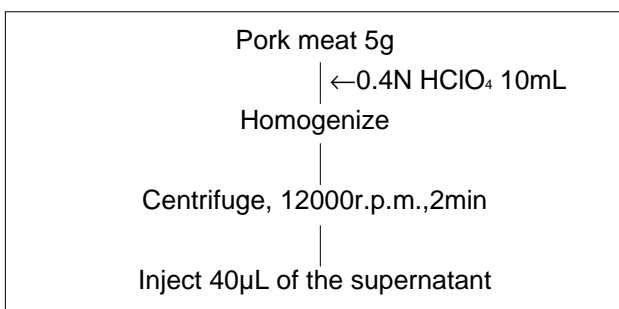

Fig. 2.2.1 Pretreatment

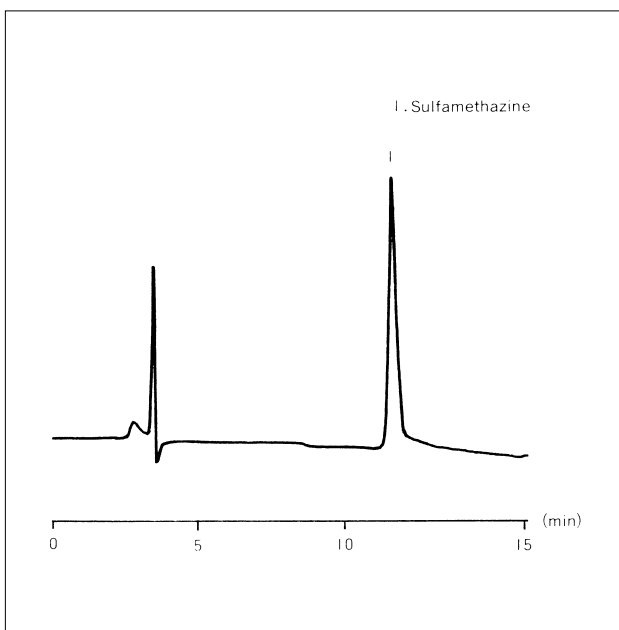

Fig. 2.2.2 Analysis example of sulfamethazine standard product

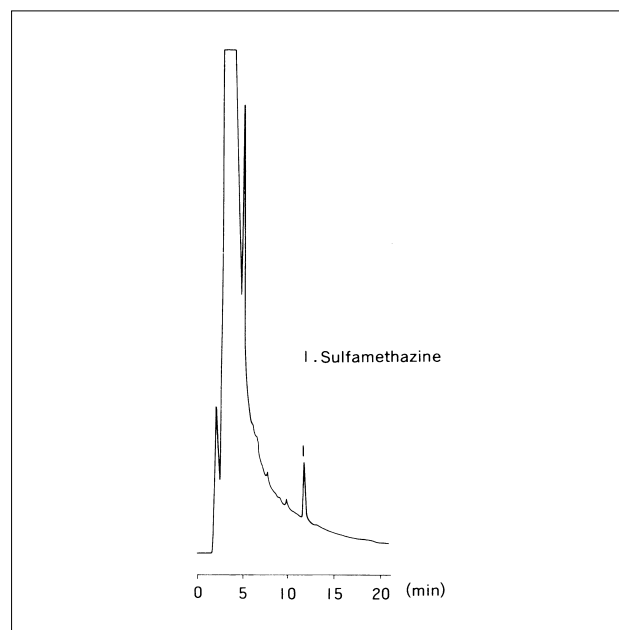

Fig. 2.2.3 Analysis example of pork



2.3 Analysis of Antibiotics and Synthetic Antibacterial Agents in Livestock and Farmed Fish (1) - LC

•Explanation

When drugs are injected into livestock and farmed fish, the amount of internal drug residue fluctuates with the speed of absorption and excretion. Generally speaking the greater the amount of drug injected the greater the internal residue will be; however, comparisons of different drugs show that residue is determined by the amounts absorbed and excreted, which depends on the physical nature of the drug concerned.

The Food Sanitation Law and related regulations state that drug residue must not be detected. However, the residual drug detection limit that used to be in the ppm order has moved on via ppb to the ppt order with

advancements in analysis equipment and analysis method. Now, test methods are being proposed with even greater detection limit sensitivity. If the analytical value for such a test method is below the detection limit, it will be considered that there is "no residue". The aim is for this value to be in the order of 20 to 30ppb.

High-performance liquid chromatography is indispensable in analysis of synthetic antibacterial agents and antibiotics from the point of view of pretreatment ease, and data sensitivity and reproducibility. This data introduces residue analysis for drugs frequently used in chickens and farmed eels.

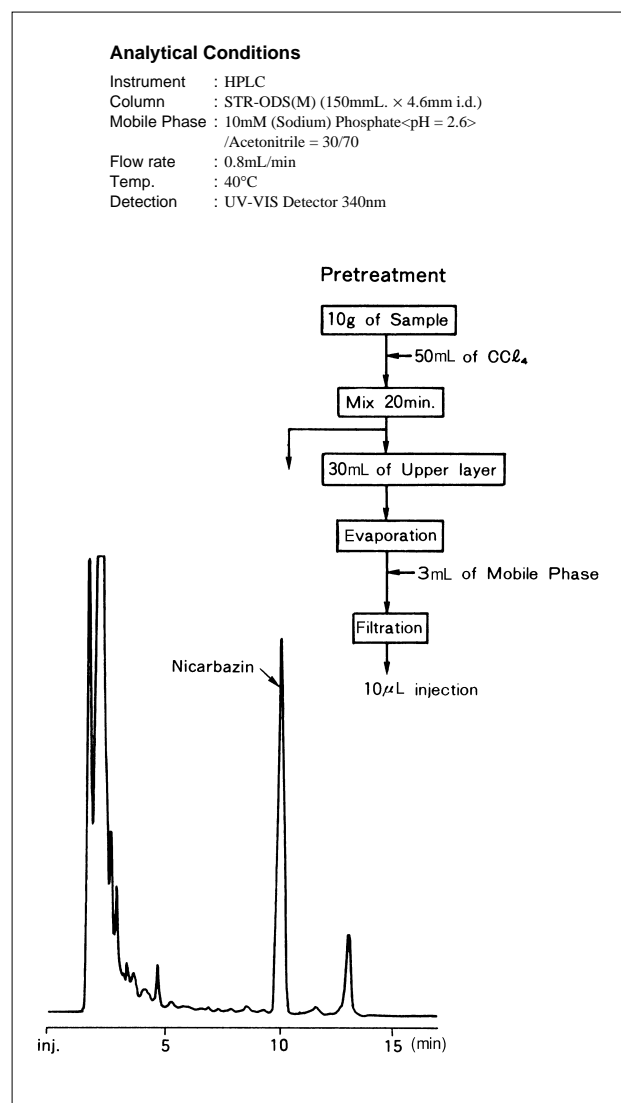
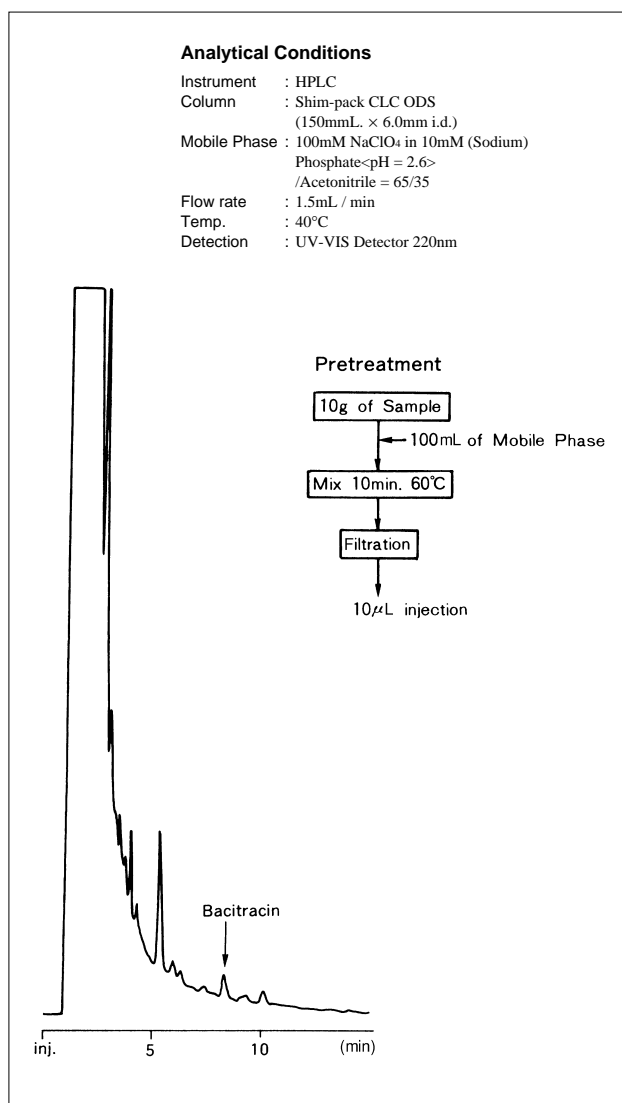

2.3 Analysis of Antibiotics and Synthetic Antibacterial Agents in Livestock and Farmed Fish (2) - LC

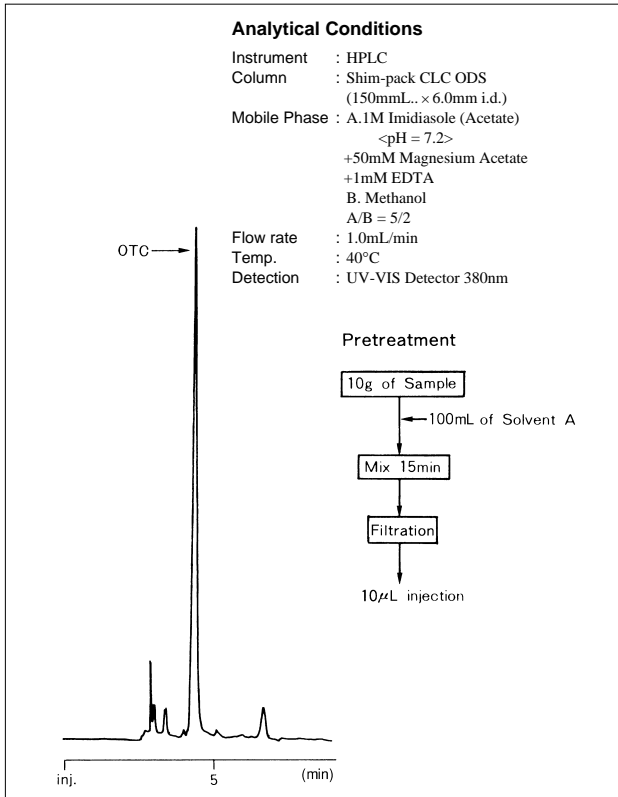

Fig. 2.3.3 Analysis of oxytetracycline in eel

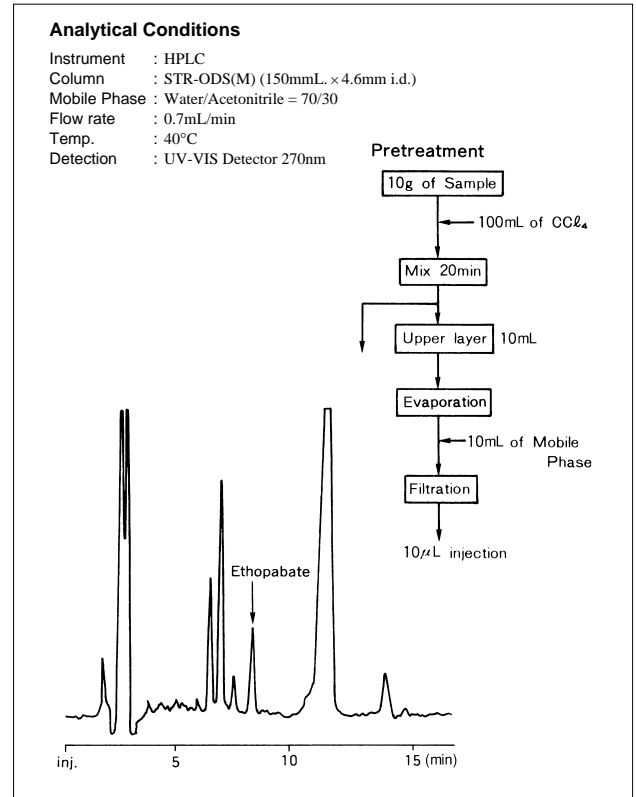

Fig. 2.3.4 Analysis of ethopabate in eel

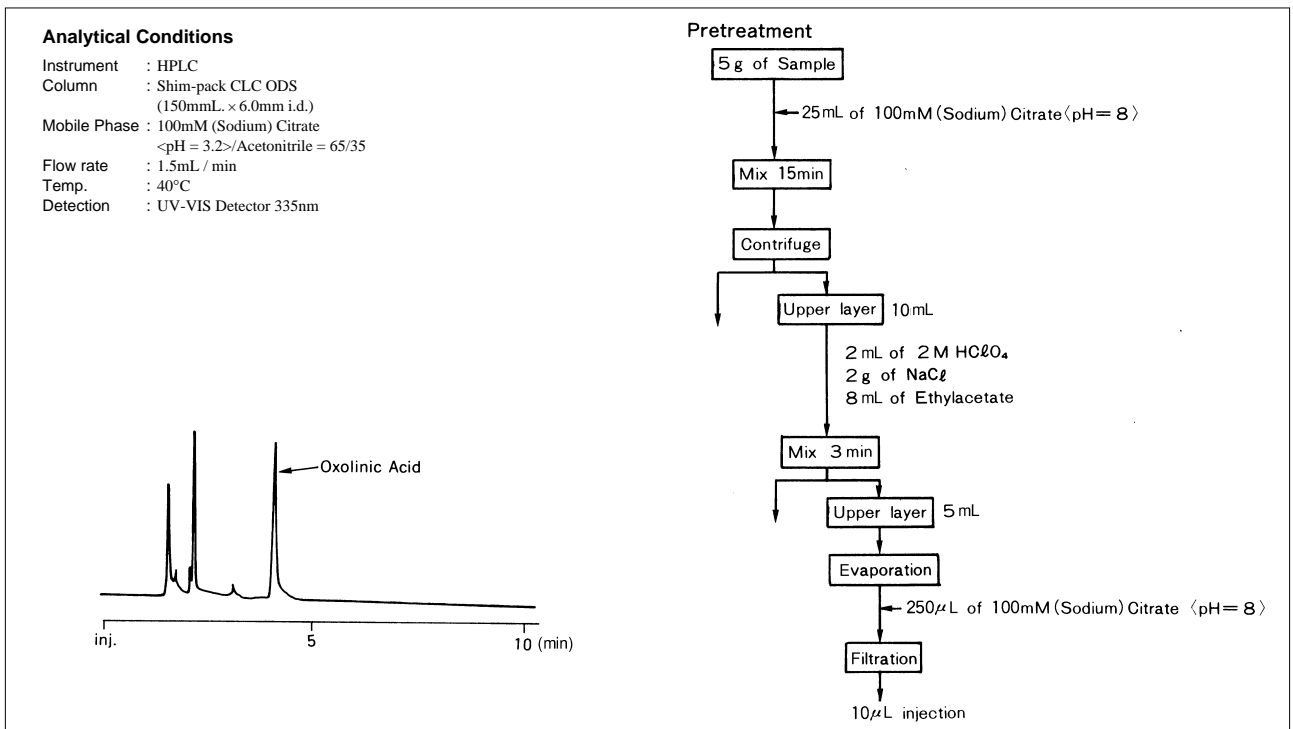

Fig. 2.3.5 Analysis of oxolinic acid in eel



2.4 Analysis of Pharmaceuticals for Animals (1) - LC

Many animal-orientated pharmaceuticals are used to prevent sickness and increase the healthiness of animals. The lower limit values for these drugs and accompanying analysis methods were published in the official gazette for December 1995 (Official Gazette, Volume 245,

Ministry of Health and Welfare, 26 Dec 1995). This data introduces analysis examples of several animal-orientated pharmaceuticals using analysis conditions conforming to the official gazette.

◆ Analysis of Flubendazole

• Explanation

Fig. 2.4.1 shows the analysis result for a standard solution of 1ppm of flubendazole. A spectrum acquired using a

photodiode array UV and visible spectrophotometer is shown in Fig. 2.4.2.

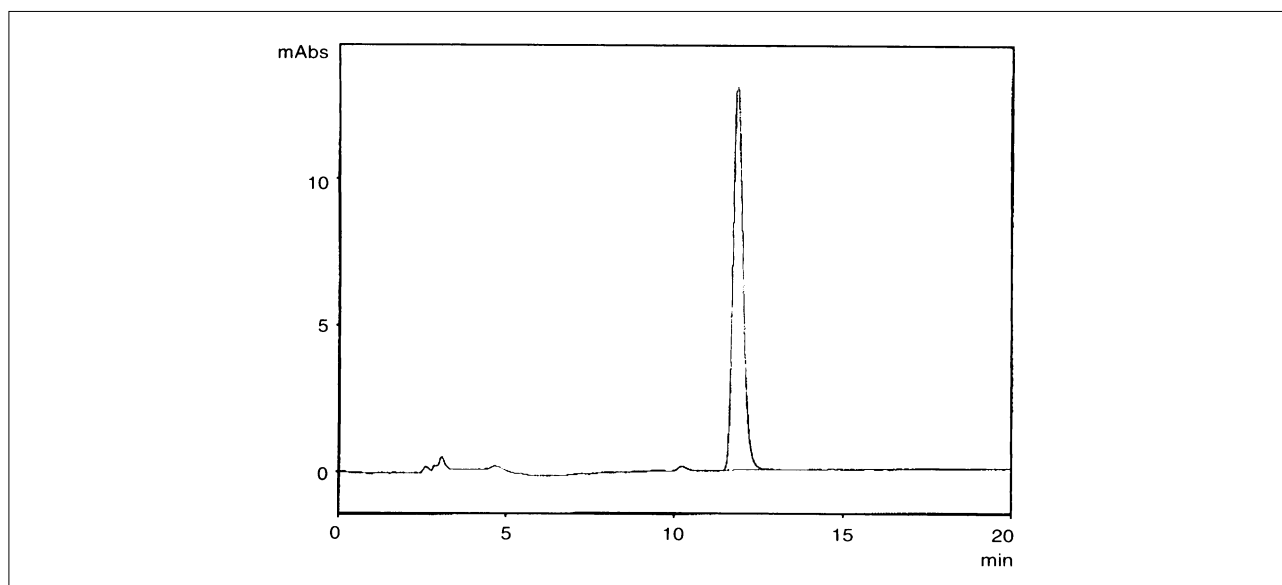

Fig. 2.4.1 Chromatogram of flubendazole standard product (1ppm)

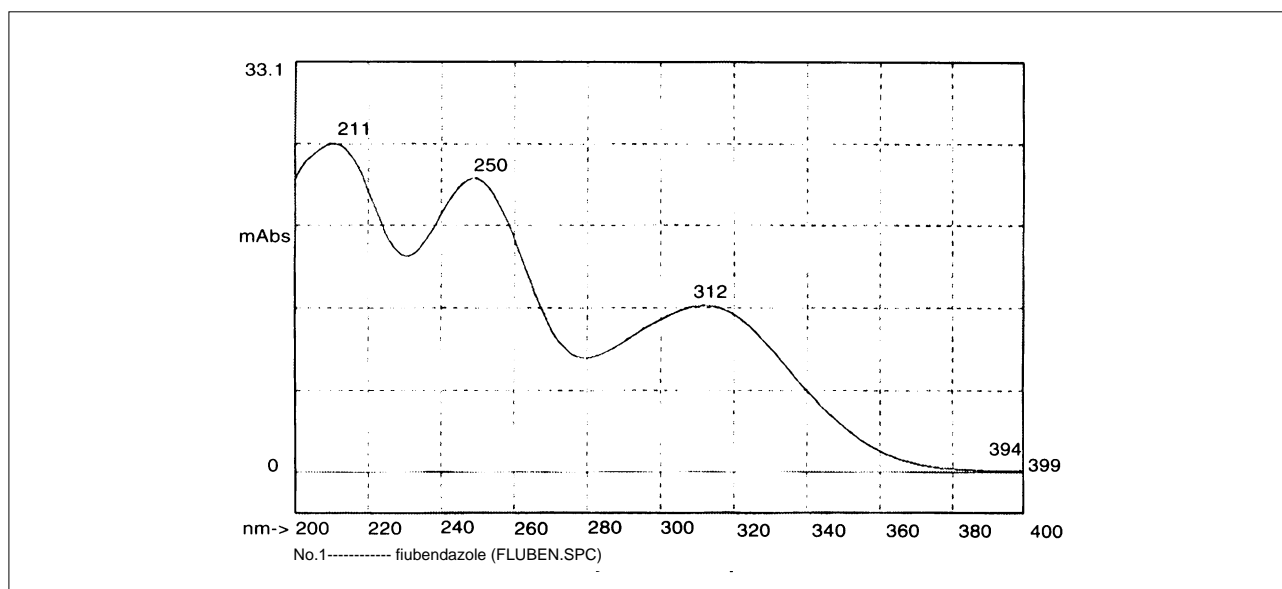

Fig. 2.4.2 Spectrum of flubendazole standard product

2.4 Analysis of Pharmaceuticals for Animals (2) - LC

◆ Analysis of Zeranol

• Explanation

Fig. 2.4.3 shows results of analysis on 10ppm of zeranol standard solution conforming to the official gazette. Fig. 2.4.4 shows a spectrum under the same conditions.

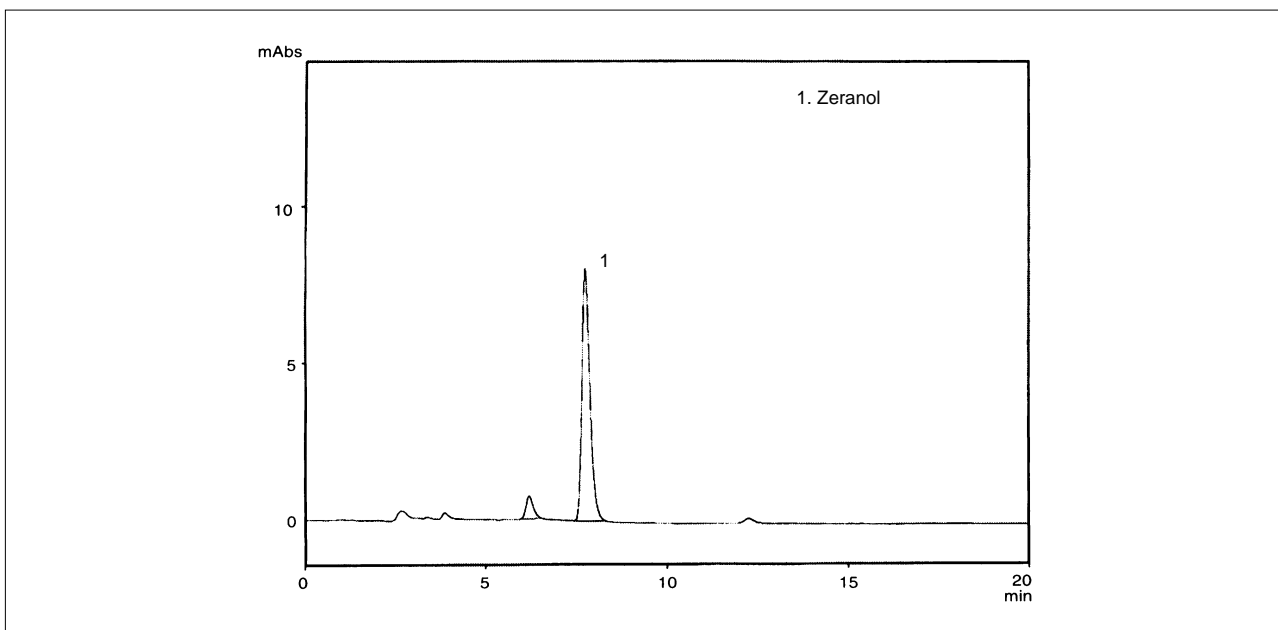

Fig. 2.4.3 Chromatogram of zeranol standard product

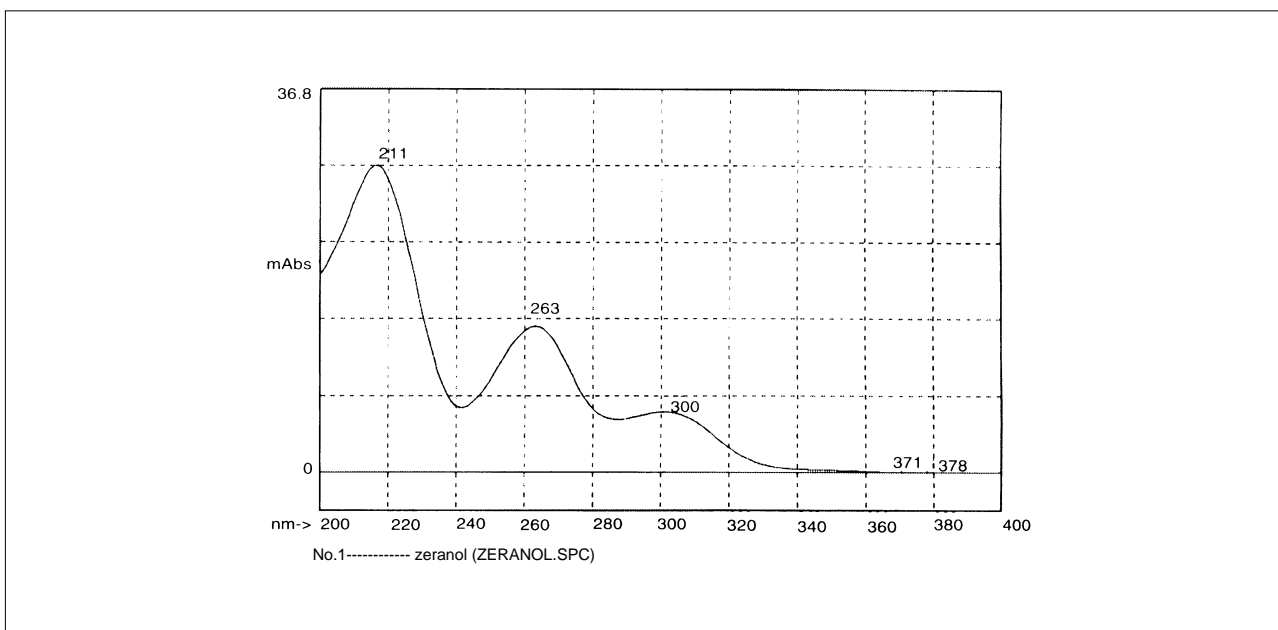

Fig. 2.4.4 Spectrum of zeranol standard product



2.4 Analysis of Pharmaceuticals for Animals (3) - LC

◆ Analysis of Oxytetracycline

• Explanation

Fig. 2.4.5 shows a chromatogram where 0.5ppm of oxytetracycline has been added to the liquid extracted from commercially available pig liver in accordance with the official gazette.

• Pretreatment

5g sample
| 0.01M EDTA2Na
| Containing 100mL Mc Ilvaine buffer solution
Homogenize
| 100mL hexane
Shake vigorously (5 min)
|
Centrifuge (3,500 rpm at room Temp. for 10 min)
|
Riffle lower layer
|
Filtration
|
50mL filtrate
|
Sep-Pak Plus PS2
| Wash with 30mL distilled water
| Solve out with 10mL methanol
Concentrated drying and hardening (35 to 40°)
| 2.5mL phosphate buffer solution
HPLC

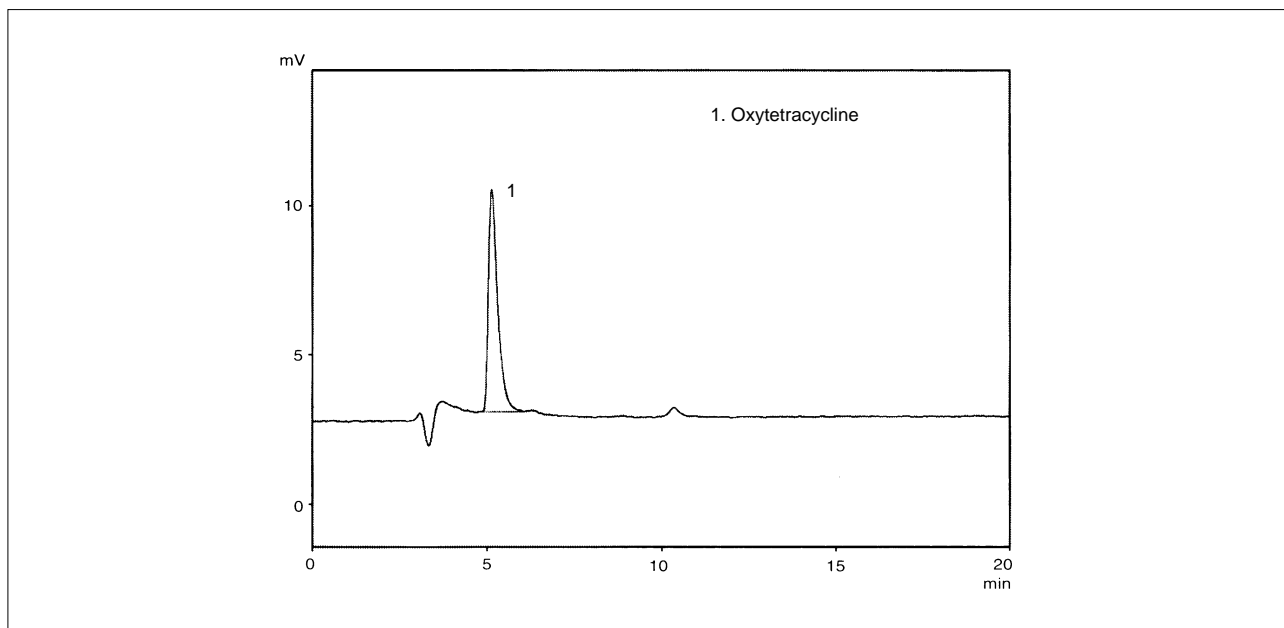

Fig. 2.4.5 Commercially available pig liver extract liquid (with 0.5ppm oxytetracycline added)

2.4 Analysis of Pharmaceuticals for Animals (4) - LC

◆ Analysis of Closantel

• Explanation

Fig. 2.4.6 shows a chromatogram where 1.0ppm of closantel has been added to the liquid extracted from commercially available pig liver in accordance with the

official gazette.

Fig. 2.4.7 shows a comparison of the standard product and extract liquid spectrums.

• Pretreatment

5g sample	
70mL acetonitrile	
70mL acetonitrile saturated hexane	
Homogenize Centrifuge (2,600rpm, 5 min)	
Transfer to separating funnel	
Lower layer	Upper layer
30mL acetonitrile	
saturated hexane	
Shake vigorously	
Lower layer	Upper layer
	10ml acetonitrile
	Shake vigorously
	Lower layer
10mL n-propanol	
Vacuum concentrated drying and hardening	
Residue	
Dissolve in 5mL acetonitrile	
C ₁₈ cartridge	
5mL acetonitrile x double flushing	
Collect total amount of acetonitrile	
Vacuum concentrated drying and hardening	
Residue	
MetMethanol water (7:2)	
Dissolve in 2mL (6mL for liver and fat)	
Test solution	
20μL	
HPLC	

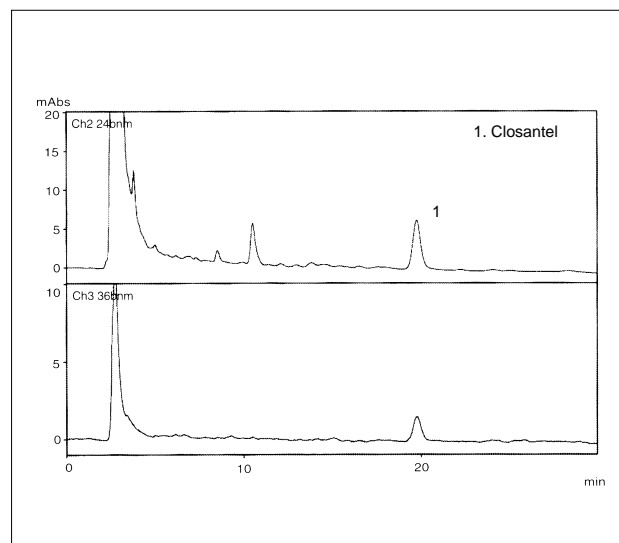

Fig. 2.4.6 Commercially available pig extract liquid (with 1.0ppm closantel added)

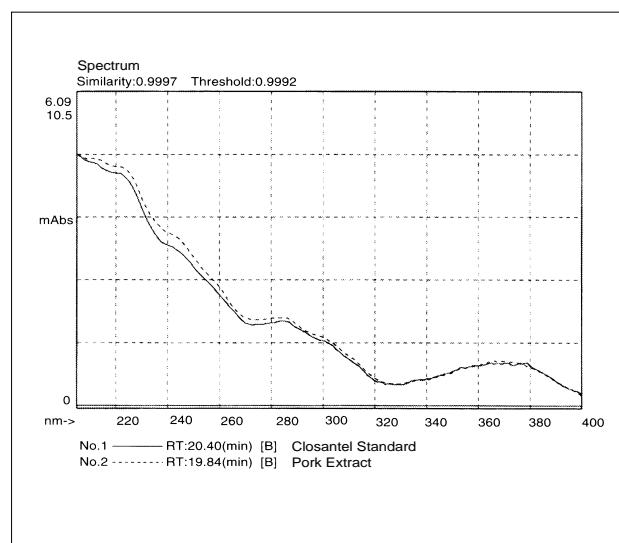

Fig. 2.4.7 Comparison of closantel standard product and extract liquid spectrums



2.5 Analysis of Mixed Feed (1) - LC

A variety of drugs are added to mixed feed fed to livestock with the aim of preventing sickness and promoting growth, etc. And the quantities of these drugs added to mixed feed are regulated and quality controlled.

•Explanation

Olaquinox is an additive used in mixed feed for piglets, etc., and works to promote the effective use of nutritious elements contained in feed. The example shows olaquinox separated using reversed-phase chromatography (Fig. 2.5.1). This substance has absorption peaks in the region of 270nm and 380nm (Fig. 2.5.2), of which 270nm shows higher sensitivity, but 380nm has better selectivity. Detection was performed at 380nm in this analysis.

•Pretreatment

This shows the pretreatment for the sample. Light must be shutout during operation because olaquinox easily changes in light.

This data introduces two of these drugs: olaquinox and lasalocid.

•Analytical Conditions

Instrument : HPLC

Column : Shim-pack CLC-ODS
(150mmL. × 6.0mm i.d.)

Mobile Phase : (A) 10mM Sodium Phosphate Buffer (pH2.6)
(B) Methanol
(A):(B)=7 : 3 (V/V)

Guard Column : Shim-pack G-ODS (4) (10mmL. × 4.0mm i.d.)

Column temp.: Room Temp.

Flow rate : 0.7mL/min

Detection : UV-VIS Detector 380nm

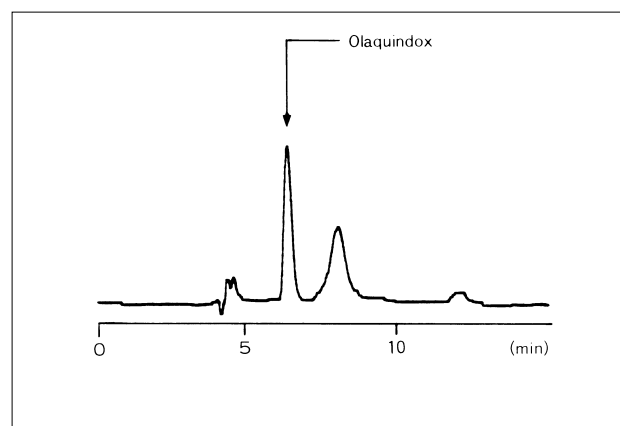
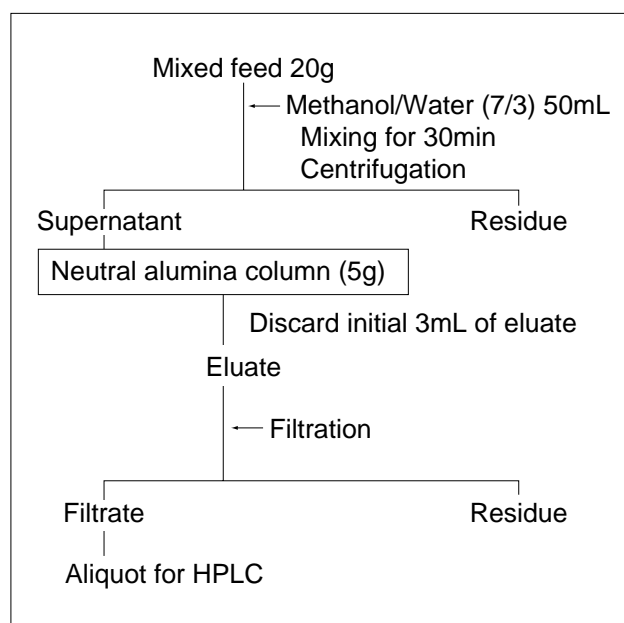

Fig. 2.5.1 Analysis example for mixed feed

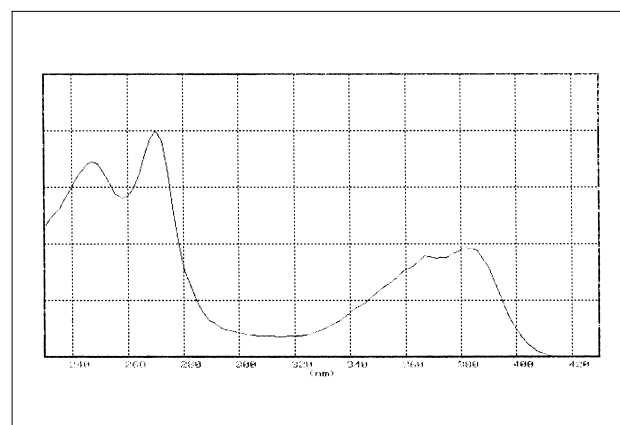

Fig. 2.5.2 Spectrum of standard product

2.5 Analysis of Mixed Feed (2) - LC

◆ Analysis of Lasalocid

● Explanation

Lasalocid is a polyether group antibiotic added to feed for broiler chicks with the aim of preventing coccidiosis. However, if excessive amounts of this substance are given to hens, it can cause development disability, so feed producers are obligated to control this.

This data shows an example of lasalocid contained in broiler chick mixed feed that has been separated using reversed-phase chromatography. Detection was performed using both ultraviolet absorption and fluorescence detectors. The fluorescence detector is more effective for sensitivity and selectivity.

● Pretreatment

Sample pretreatment involves extraction with chloroform, followed by adsorption in a silica gel column and elution with methanol. However, in the case of samples containing a lot of lasalocid, such as premix, they are more conveniently prepared by extracting the lasalocid with methanol, filtering it, and injecting that filtrate as it is.

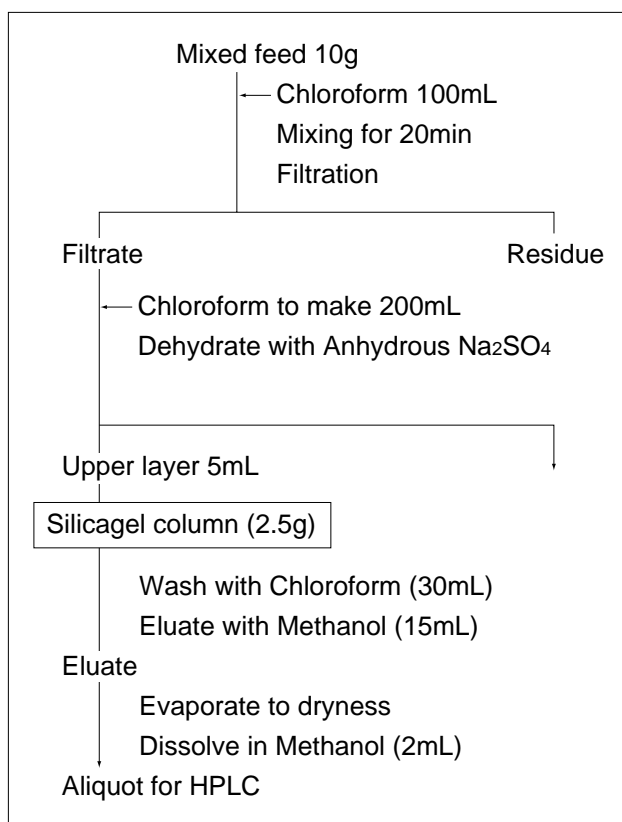

● Analytical Conditions

Instrument : HPLC

Column : Shim-pack CLC-ODS
(150mmL. × 6.0mm i.d.)

Mobile Phase : Methanol/Water = 9/1(V/V)
Containing 100mM NaClO₄

Guard Column : Shim-pack G-ODS (4) (10mmL. × 4.0mm i.d.)

Column temp.: 40°C

Flow rate : 1.0mL/min

Detection : UV-VIS Detector 310nm
Fluorescence Detector Ex310nm, Em425nm

References

Mixed feed containing lasalocid was provided by Marubeni Shiryo Corporation.

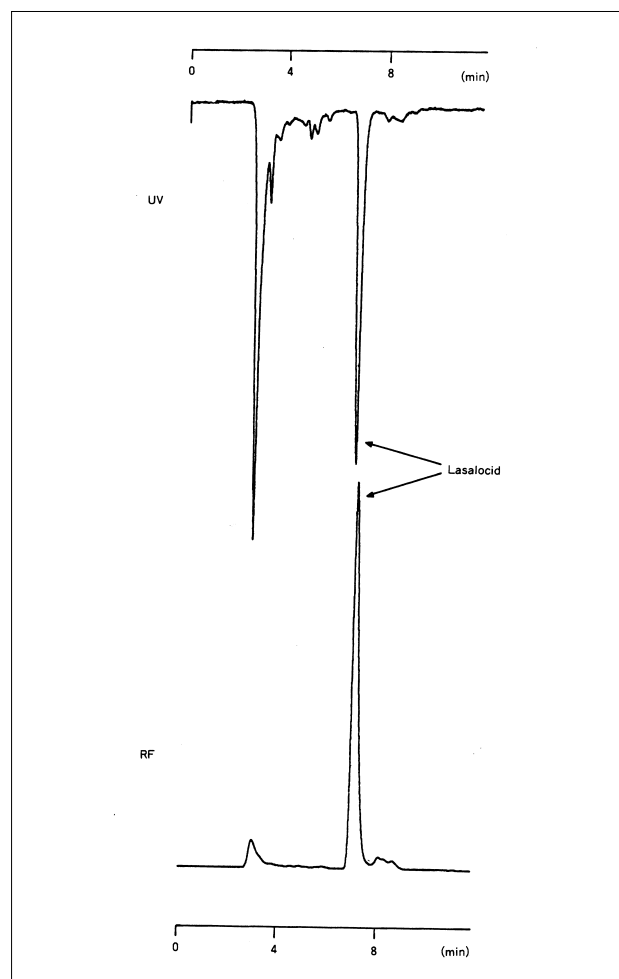

Fig. 2.5.3 Analysis example of mixed feed



3. Crude drugs and Natural Substances

3.1 Analysis of Capsaicin in Red Pepper Tincture - GC

•Explanation

This data introduces analysis of capsaicin in a red pepper tincture.

•Pretreatment

Capsaicin and red pepper tincture were dissolved in methanol, and 1 μ L injected.

•Analytical Conditions

Instrument	: GC-14BPFsc
Column	: DB-1 30m \times 0.25mm i.d. df=0.25 μ m
Col.Temp.	: 270 $^{\circ}$ C
Inj.Temp.	: 300 $^{\circ}$ C
Det.Temp.	: 300 $^{\circ}$ C(FID)
Carrier Gas	: He 0.5mL/min
Injection	: Split 1 : 100

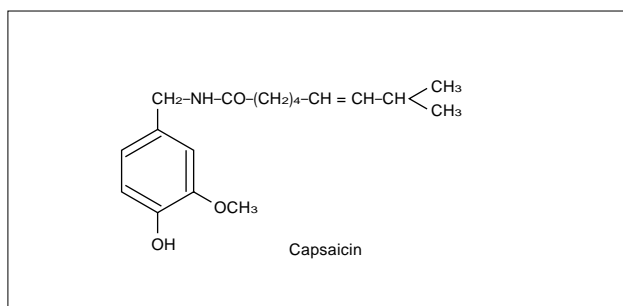

Fig. 3.1.1 Structural formula of capsaicin

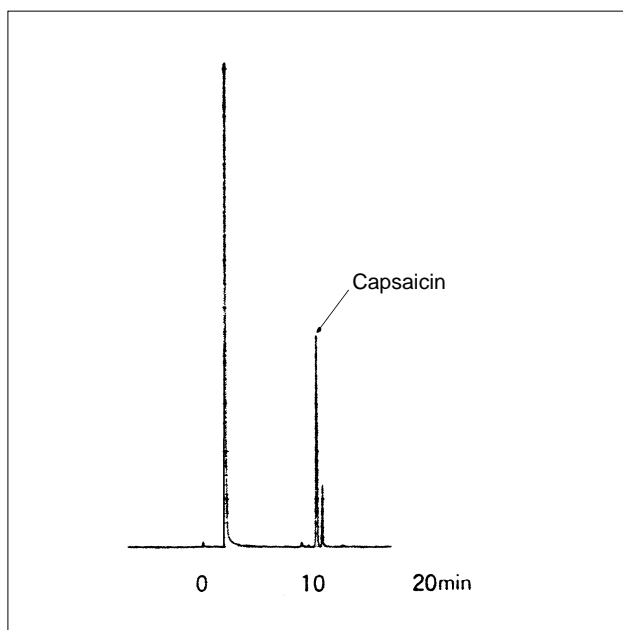

Fig. 3.1.2 Chromatogram of capsaicin standard product

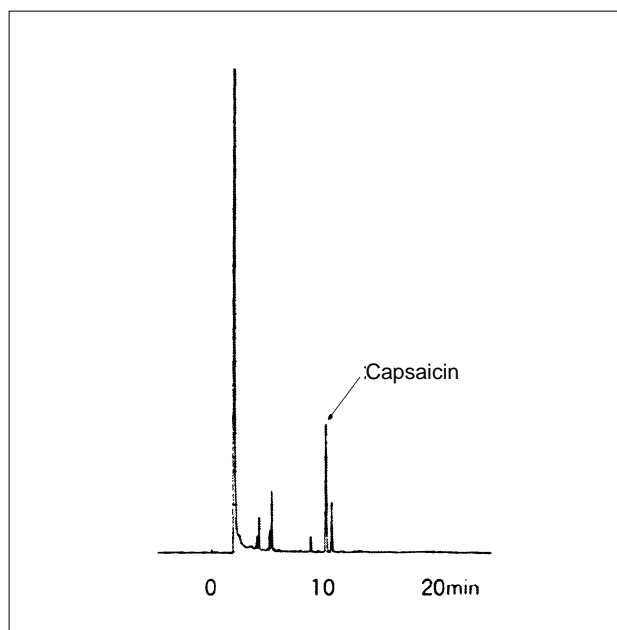

Fig. 3.1.3 Chromatogram of capsaicin in red pepper tincture

3.2 Analysis of Pharmaceutical (Beeswax) - GCMS

•Explanation

The beeswax in this analysis was refined from wax taken from a beehive, and is used as a base in the production of ointments and salves and as a cosmetic material in creams, etc. Beeswax mostly comprises higher fatty acid and higher alcohol ester.

•Analytical Conditions

Instrument : GCMS-QP5050A
 — GC —
 Column : DB - 5 (30m × 0.25mm i.d. df = 0.1µm)
 Column Temp. : 60°C (2min) - 20°C/min-200°C
 -10°C/min-300°C - 15°C/min-350°C

— MS —

Interface Temp. : 280°C
 Ionization Method : EI
 Scan Range : m/z 35-700
 Scan Interval : 0.5sec

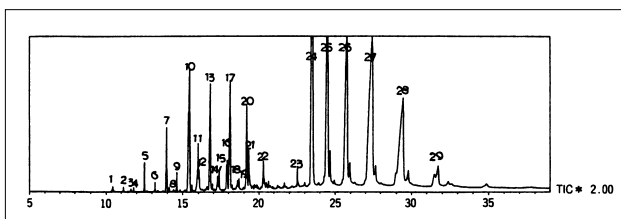

Fig. 3.2.1 Total ion chromatogram of beeswax

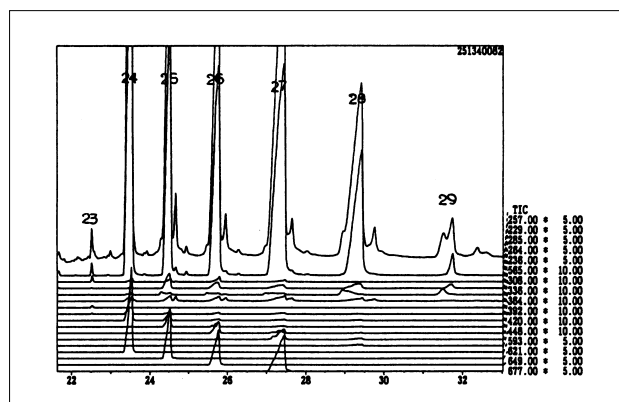
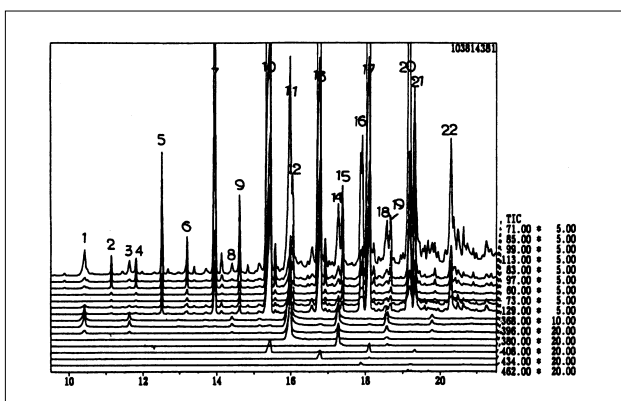

Fig. 3.2.2 Mass chromatogram of beeswax

Chart 3.2.1 Beeswax Qualitative Results

No.	Molecular Weight	Chemical Formula	Compound Name	No.	Molecular Weight	Chemical Formula	Compound Name
1	256	C ₁₅ H ₃₁ COOH	Palmitic acid	16	434	C ₃₁ H ₆₂	1-hentriacontane
2	296	C ₂₁ H ₄₄	Heneicosane	17	436	C ₃₁ H ₆₄	Hentriacontane
3	284	C ₁₇ H ₃₅ COOH	Stearic acid	18	424	C ₂₇ H ₅₅ COOH	Montan acid
4	310	C ₂₂ H ₄₆	Docosane	19	450	C ₃₂ H ₆₆	Dotriacontane
5	324	C ₂₃ H ₄₈	Tricosane	20	462	C ₃₃ H ₆₆	1-tritriacontane
6	338	C ₂₄ H ₅₀	Tetracosane	21	464	C ₃₃ H ₆₈	Tritriacontane
7	352	C ₂₅ H ₅₂	Pentacosane	22	490	C ₃₅ H ₇₀	1-pentatriacontane
8	340	C ₂₁ H ₄₃ COOH	Behenic acid	23	564	C ₁₅ H ₃₁ COOC ₂₂ H ₄₅	Palmitic acid docosane
9	366	C ₂₆ H ₅₄	Hexacosane	24	592	C ₁₅ H ₃₁ COOC ₂₄ H ₄₉	Palmitic acid tetracosane
10	380	C ₂₇ H ₅₆	Heptacosane	25	620	C ₁₅ H ₃₁ COOC ₂₆ H ₅₃	Palmitic acid hexacosane
11	368	C ₂₃ H ₄₇ COOH	Lignoceric acid	26	648	C ₁₅ H ₃₁ COOC ₂₈ H ₅₇	Palmitic acid octacosane
12	394	C ₂₈ H ₅₈	Octacosane	27	676	C ₁₅ H ₃₁ COOC ₃₀ H ₆₁	Palmitic acid triacontane
13	408	C ₂₉ H ₆₀	Nonacosane	28	704	C ₁₅ H ₃₁ COOC ₃₂ H ₆₅	Palmitic acid dotriacontane
14	396	C ₂₅ H ₅₁ COOH	Cerotic acid	29	732	C ₁₅ H ₃₁ COOC ₃₄ H ₆₉	Palmitic acid tetratriacontane
15	422	C ₃₀ H ₆₂	Triacosan				



3.3 Analysis of Capsaicin Using NCI-GC/MS (1) - GCMS

•Explanation

Capsaicin, that gives red pepper its "hot" flavor, was analyzed using the electron impact ionization method (EI), the positive chemical ionization method (PCI) and the negative chemical ionization method (NCI).

The EI method shown in Figs. 3.3.1 and 3.3.2 revealed fragment ions. The PCI method shown in Fig. 3.3.3 revealed a proton-added quasi-molecular ion peak (m/z 306) as the base peak. And the NCI method shown in Fig. 3.3.4 revealed that higher-sensitive detection was possible in comparison with the other ionization methods. Figs. 3.3.5, 3.3.6, 3.3.7 and 3.3.8 show measurement results for red pepper extract using EI, PCI and NCI methods. The reaction gases methane and ammonia were used for measurement with the NCI method.

•Analytical Conditions

Instrument	: GCMS-QP5050A
— GC —	
Column	: DB - 5 (30m × 0.32mm.i.d. df=0.25μm)
Column Temp.	: 60°C (1min) - 10°C/min - 280°C (20min)
Injector Temp.	: 280°C
Carrier gas	: He 100kPa
Injection Method	: Splitless (Sampling Time=2min)
— MS —	
Interface Temp.	: 250°C
Ionization Method	: EI, PCI, NCI
Scan Range	: m/z 35-600 (EI) m/z 70-600 (PCI, NCI)
Scan Interval	: 0.5sec

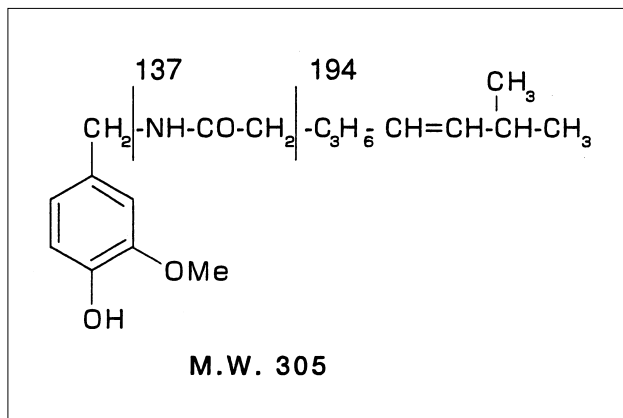

Fig. 3.3.1 Capsaicin structure

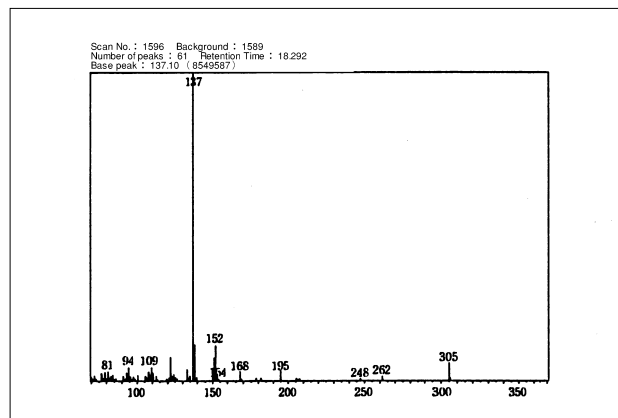

Fig. 3.3.2 EI mass spectrum of capsaicin

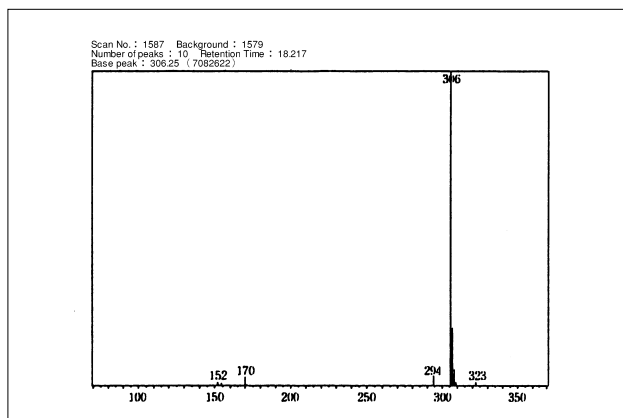

Fig. 3.3.3 PCI mass spectrum of capsaicin

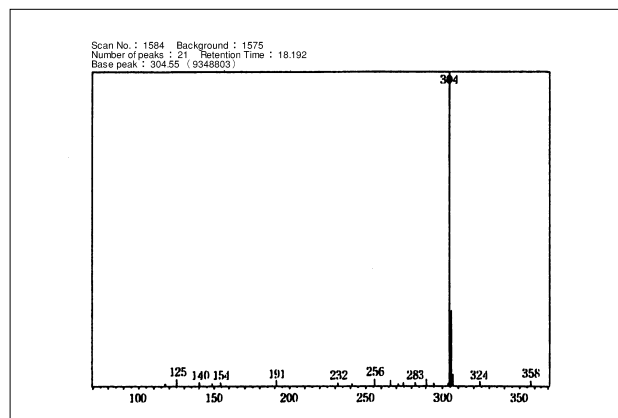

Fig. 3.3.4 NCI mass spectrum of capsaicin

3.3 Analysis of Capsaicin Using NCI-GC/MS (2)- GCMS

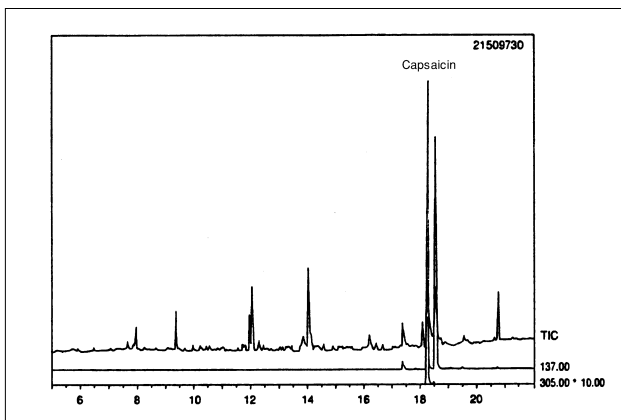

Fig. 3.3.5 Mass chromatogram of red pepper extract (EI method)

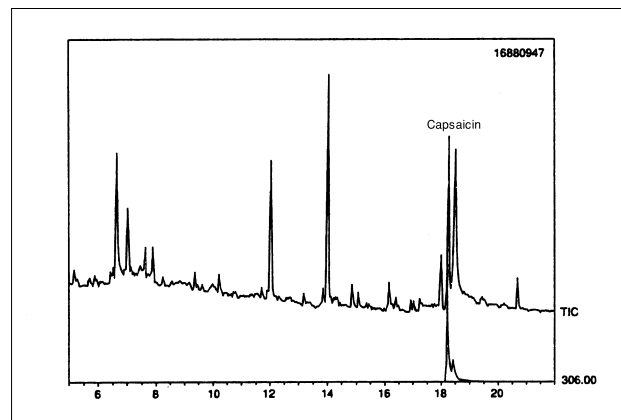

Fig. 3.3.6 Mass chromatogram of red pepper extract (PCI method)

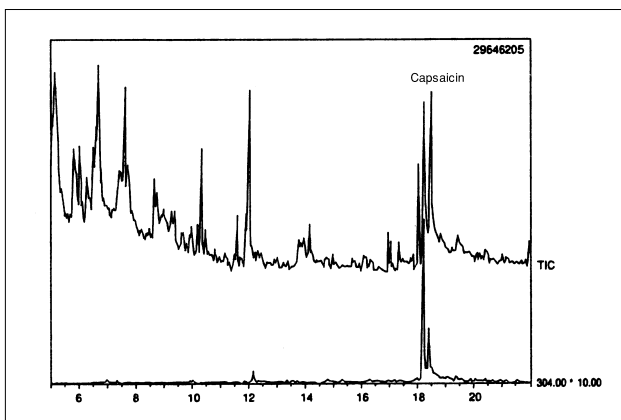

Fig. 3.3.7 Mass chromatogram of red pepper extract (NCI method: methane reaction gas)

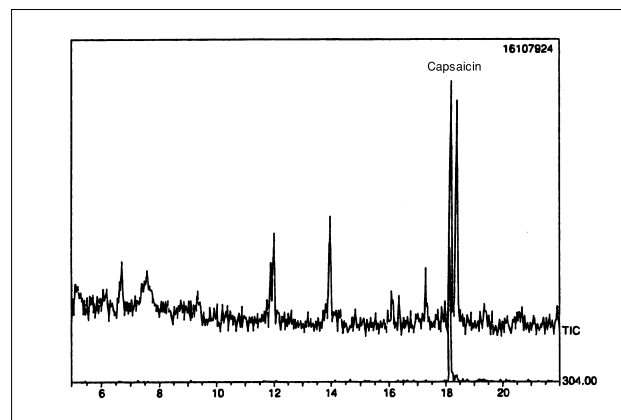

Fig. 3.3.8 Mass chromatogram of red pepper extract (NCI method: ammonia reaction gas)



3.4 NCI-GC/MS Analysis of a Crude Drug (Red Ginseng) - GCMS

•Explanation

The items of total BHC (α , β , γ , δ -BHC) and total DDT (DDT, DDE, DDD) have been newly added to the purity testing method for crude drugs. Here, the GC-ECD measuring method is used because these items are chlorine-group agrochemicals. The negative chemical ionization method (NCI-GC/MS) shows the same high sensitivity and selectivity as the ECD method for compounds with electron affinity. The NCI-GC/MS method was used to analyze targeted agrochemicals in crude drugs.

•Pretreatment

The following shows the pretreatment method.

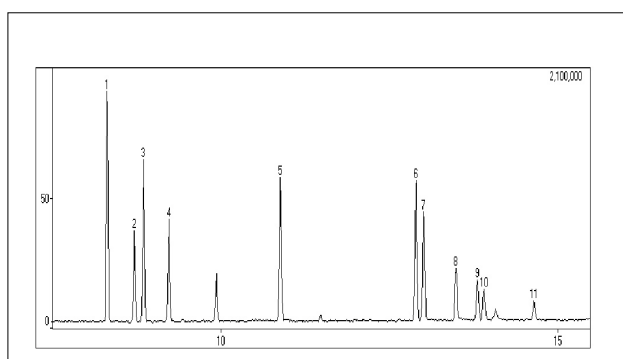
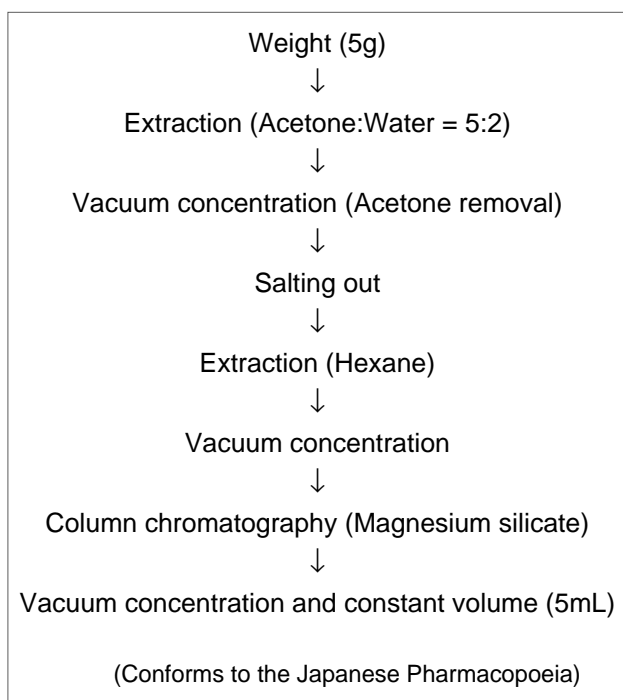

Fig. 3.4.1 Total ion chromatogram of analyzed crude drug (red ginseng)

•Analytical Conditions

Instrument	: GCMS-QP5050A
— GC —	
Column	: DB-5MS (30m × 0.25mm.i.d. df=0.25 μ m)
Column Temp.	: 50°C (2min) - 30°C/min - 180°C - 8°C/min - 280°C (3min)
Injector Temp.	: 250°C
Carrier gas	: He 100kPa
Injection Method	: Splitless (Sampling Time=2min)
Injection Volume	: 2 μ L
— MS —	
Interface Temp.	: 260°C
Ionization Method	: NCI(CH ₄ 3.5kgf/cm ²)
Scan Range	: m/z 35-350
Scan Interval	: 0.5sec

Chart 3.4.1 Targeted Agrochemicals

Peak No	Name	Peak No	Name
1	α -BHC	7	Dieldrin
2	β -BHC	8	Endrin
3	γ -BHC	9	p,p'-DDD
4	δ -BHC	10	o,p'-DDT
5	Ardrin	11	p,p'-DDT
6	p,p'-DDE		

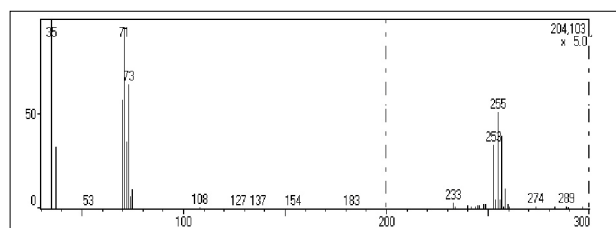

Fig. 3.4.2 NCI mass spectrum of γ -BHC (peak-3)

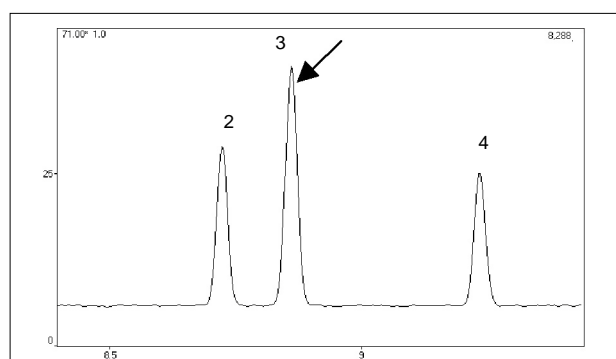

Fig. 3.4.3 SIM chromatogram (NCI) of γ -BHC (m/z:71)

3.5 Measurement of Glycyrrhizin in Licorice - LCMS

•Explanation

The licorice root is known as a crude drug and contains plenty of glycyrrhizin. Glycyrrhizin works against ulcers, inflammation, and allergies and is used in antitussive, expectorant and peptic ulcer treatments.

Glycyrrhizin is a triterpenes glycoside and among its molecules glucuronic acid has two coupled molecules. In APCI (-) measurement, m/z 645 and 469, where glucuronic acid was desorbed were observed, together with [M-H]⁻ (m/z 821) (Fig. 3.5.1 and Fig. 3.5.2). Also, APCI (+) measurement revealed the ion (m/z 471) that denotes aglycon (Fig. 3.5.3. and Fig. 3.5.4). (m/z 453 shows dehydrated ions.)

Normally LCMS measuring detects ions to show molecular weight, but with glycoside analysis, this kind of fragment ion is often observed, which assists element recognition.

•Pretreatment

Add 20mL of water to 1g of licorice root and leave for 20 min at 60°C. Filtrate the extracted liquid through a water-based membrane filter (0.45µm).

•Analytical Conditions

Instrument : LCMS-QP8000α

Column : Inertsil ODS - 3
(2.1mm i.d. × 150mmL)

Mobile phase A : 20mM(ammonium) acetate(pH4.5)

Mobile phase B : methanol

Flow rate : 0.2 mL/min

Temperature : 40°C

Time program :

Time (min)	Function	Value
0	B.Conc	50
10	B.Conc	90
15	B.Conc	90
15.01	B.Conc	50
25	STOP	

Mode : APCI (+), APCI (-)

Mass range : m/z 300-1,000

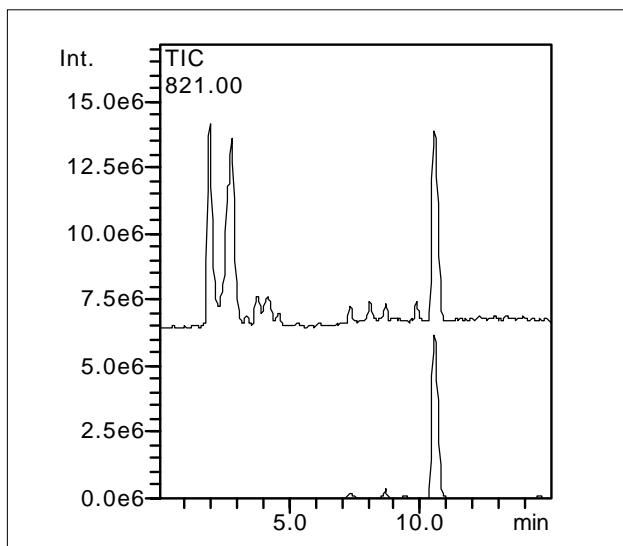

Fig. 3.5.1 TIC and mass chromatogram using APCI (-)

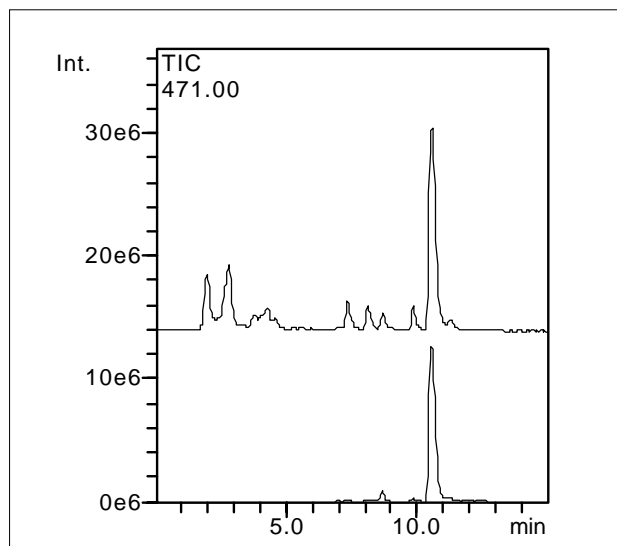

Fig. 3.5.3 TIC and mass spectrum using APCI (+)

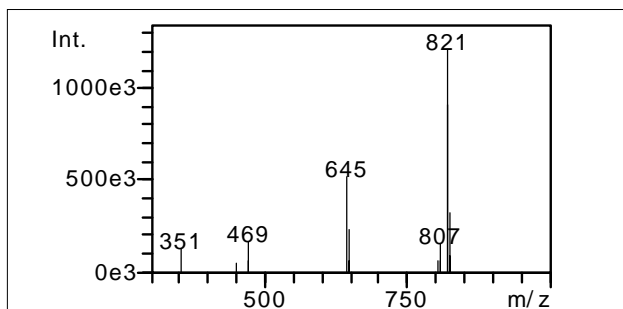

Fig. 3.5.2 Mass spectrum (APCI (-)) of glycyrrhizin

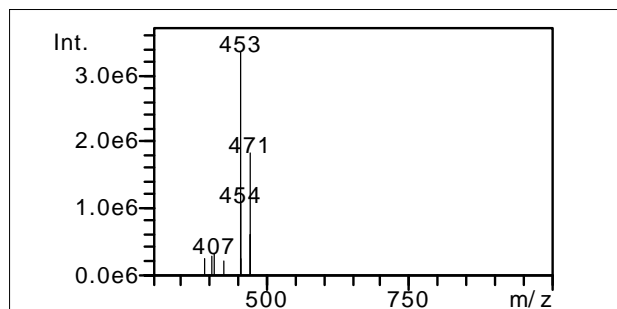

Fig. 3.5.4 Mass spectrum (APCI (+)) of glycyrrhizin



3.6 HPLC Analysis of a Crude Drug (1)- LC

In the 12th revision of the Japanese Pharmacopoeia, high-performance liquid chromatography (HPLC) method is designated as the quantitative method for crude drugs and as the measuring method for amounts of elements contained, targeting 7 elements in 20 kinds of crude drugs. This data shows examples for berberine in coptis

◆ Analysis of Berberine in Coptis Rhizome (Japanese Goldthread)

● Explanation

Berberine is an alkali, so adsorption occurs during analysis in the normally used silica-based column. To curb this adsorption, counter ions are added to the mobile phase. Sodium lauryl sulphate was used for the official conditions and sodium perchlorate for the Shimadzu easy method.

● Pretreatment

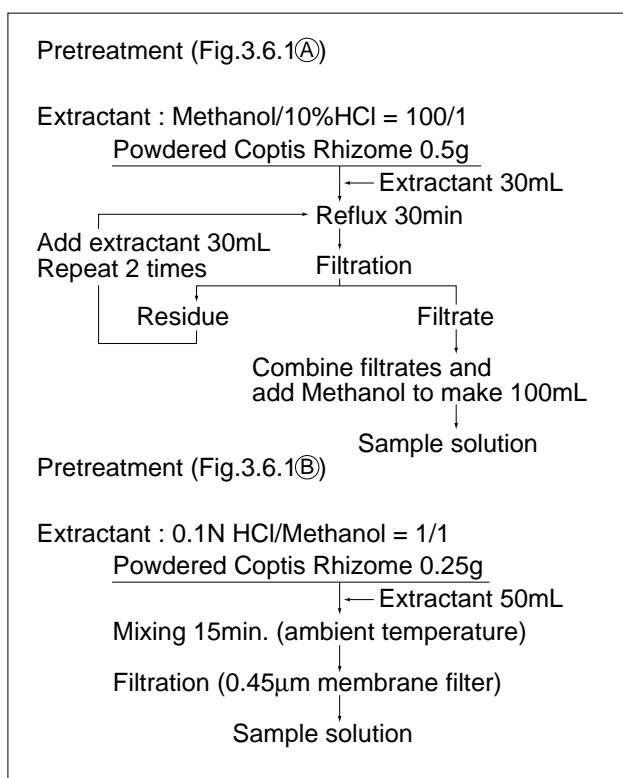

rhizome (Japanese goldthread), scopolamine and hyoscyamine in root extract, and arbutin in bearberry using both a chromatogram obtained with pretreatment and analysis conditions conforming to the Pharmacopoeia and a Shimadzu chromatogram obtained with a simple pretreatment method and fast analysis conditions.

● Analytical Conditions (Fig. 3.6.1 (A))

Instrument : HPLC

Column : STR ODS-M (150mmL. × 4.6mm i.d.)

Mobile Phase : Potassium Dihydrogenphosphate 3.4g,
Sodium Lauryl Sulfate 1.7g in 1L of
Water/Acetonitrile = 1/1

Flow Rate : 0.6mL/min

Temperature: 40°C

Detection : UV-VIS Detector 345nm

● Analytical Conditions (Fig. 3.6.1 (B))

Instrument : HPLC

Column : STR ODS-M (150mmL. × 4.6mm i.d.)

Mobile Phase : 200mM Sodium Perchlorate in 10mM (Sodium)
Phosphate Buffer(pH = 2.6)/
Acetonitrile = 5/3

Flow Rate : 1.0mL/min

Temperature: 40°C

Detection : UV-VIS Detector 345nm

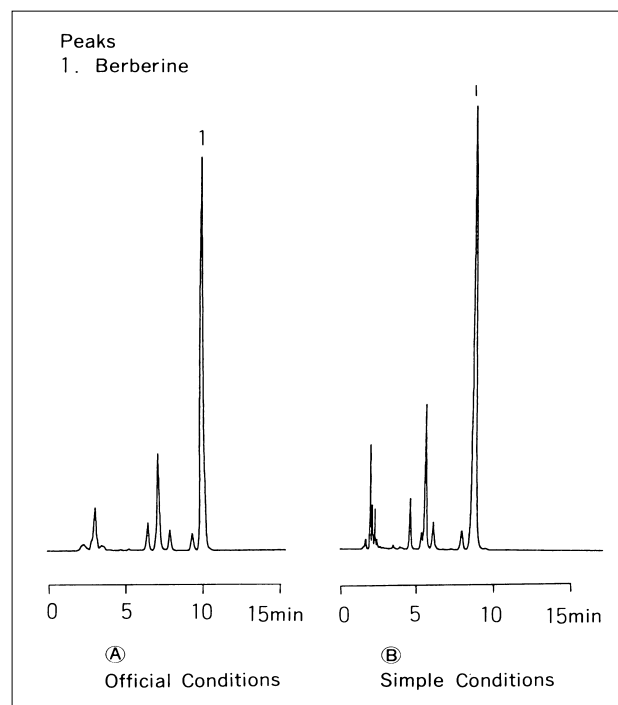

Fig. 3.6.1 Analysis of berberine in coptis rhizome (Japanese goldthread) powder

3.6 HPLC Analysis of a Crude Drug (2)- LC

◆ Analysis of Scopolamine and Hyoscyamine in Root Extract

● Explanation

Triethylamine is used with the official condition as a tailing prevention and sodium perchlorate was used for the simple conditions in the same way as for berberine. Also, with the simple conditions, the internal standard product brucine has not been added, but if brucine was to be analyzed at the same time, the holding time would be approximately 12.5 min.

● Pretreatment

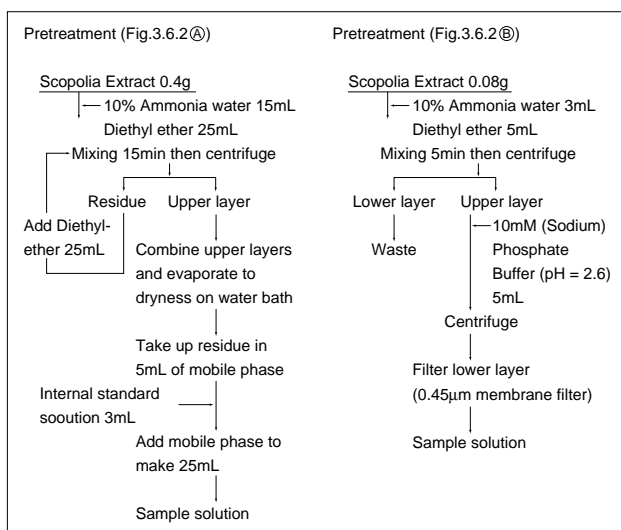

● Analytical Conditions (Fig. 3.6.2 (A))

Instrument : HPLC
 Column : STR ODS-M (150mmL. × 4.6mm i.d.)
 Mobile Phase : Potassium Dihydrogenphosphate 6.8g,
 Triethylamine 10mL in 1L of Water
 (Adjust pH to 3.5 with H₃PO₄)/
 Acetonitrile = 9/1
 Flow Rate : 0.8mL/min
 Temperature: Ambient
 Detection : UV-VIS Detector 210nm

● Analytical Conditions (Fig. 3.6.2 (B))

Instrument : HPLC
 Column : STR ODS-M (150mmL. × 4.6mm i.d.)
 Mobile Phase : 100mM Sodium Perchlorate in 10mM (Sodium)
 Phosphate Buffer(pH = 2.6)/
 Acetonitrile = 3/1
 Flow Rate : 1.0mL/min
 Temperature: 40°C
 Detection : UV-VIS Detector 210nm

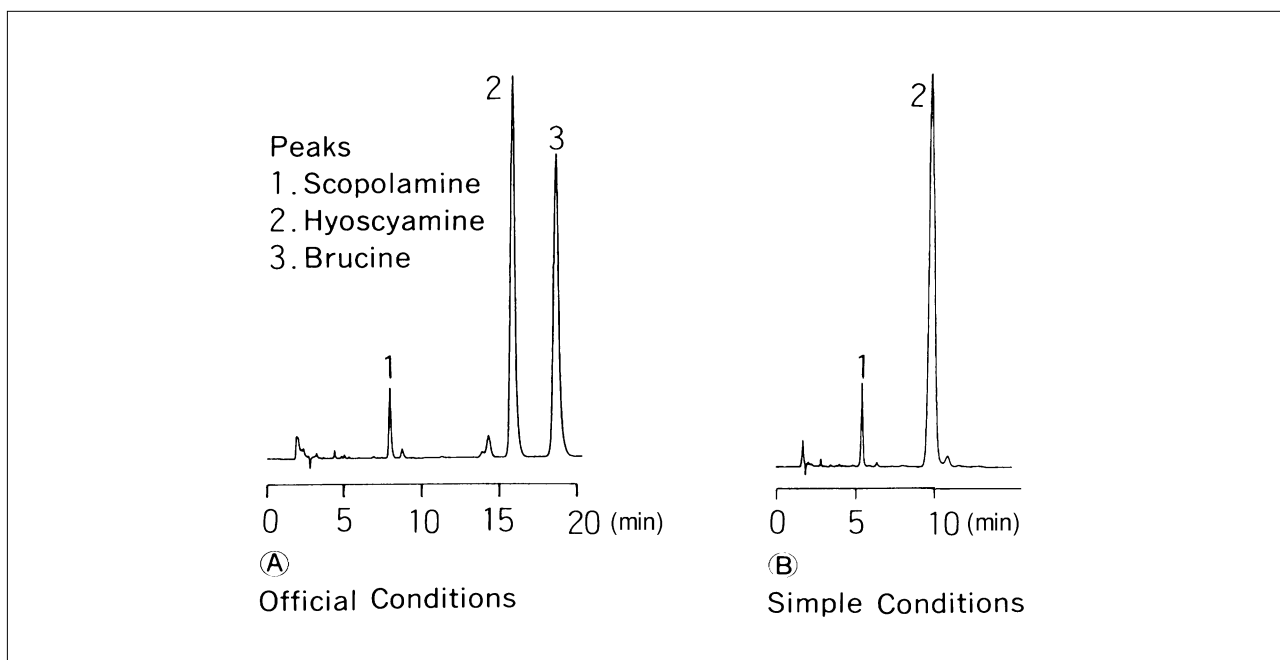

Fig. 3.6.2 Analysis of scopolamine and hyoscyamine in root extract



3.6 HPLC Analysis of a Crude Drug (3)- LC

◆ Arbutin in Bearberry

• Explanation

This data shows chromatograms for the official conditions using hydrochloride water solution as the mobile phase and the simple conditions using an acidic phosphate buffer. The simple conditions are considered appropriate for fully separating hydroquinone and gallic acid that coexist with arbutin in actual samples.

• Pretreatment

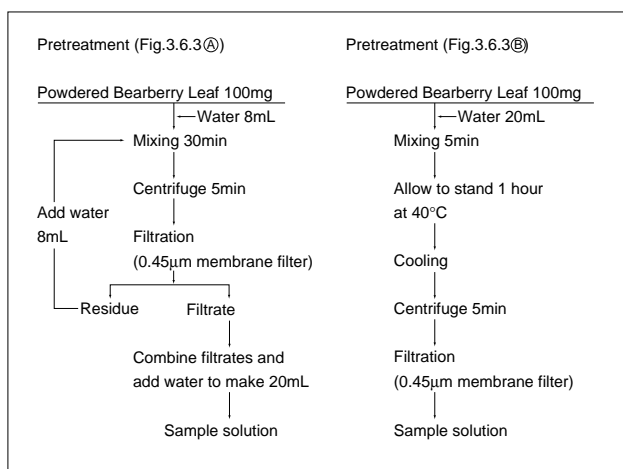

• Analytical Conditions (Fig. 3.6.3 (A))

Instrument : HPLC
Column : STR ODS-M (150mmL. × 4.6mm i.d.)
Mobile Phase: Water/Methanol/0.1N Hydrochloric Acid = 94/5/1
Flow Rate : 0.8mL/min
Temperature: Ambient temp.
Detection : UV-VIS Detector 280nm

• Analytical Conditions (Fig. 3.6.3 (B))

Instrument : HPLC
Column : STR ODS-M (150mmL. × 4.6mm i.d.)
Mobile Phase: 100mM (Sodium) Phosphate Buffer (pH = 2.1)/Methanol = 40/1
Flow Rate : 0.8mL/min
Temperature: 40°C
Detection : UV-VIS Detector 280nm

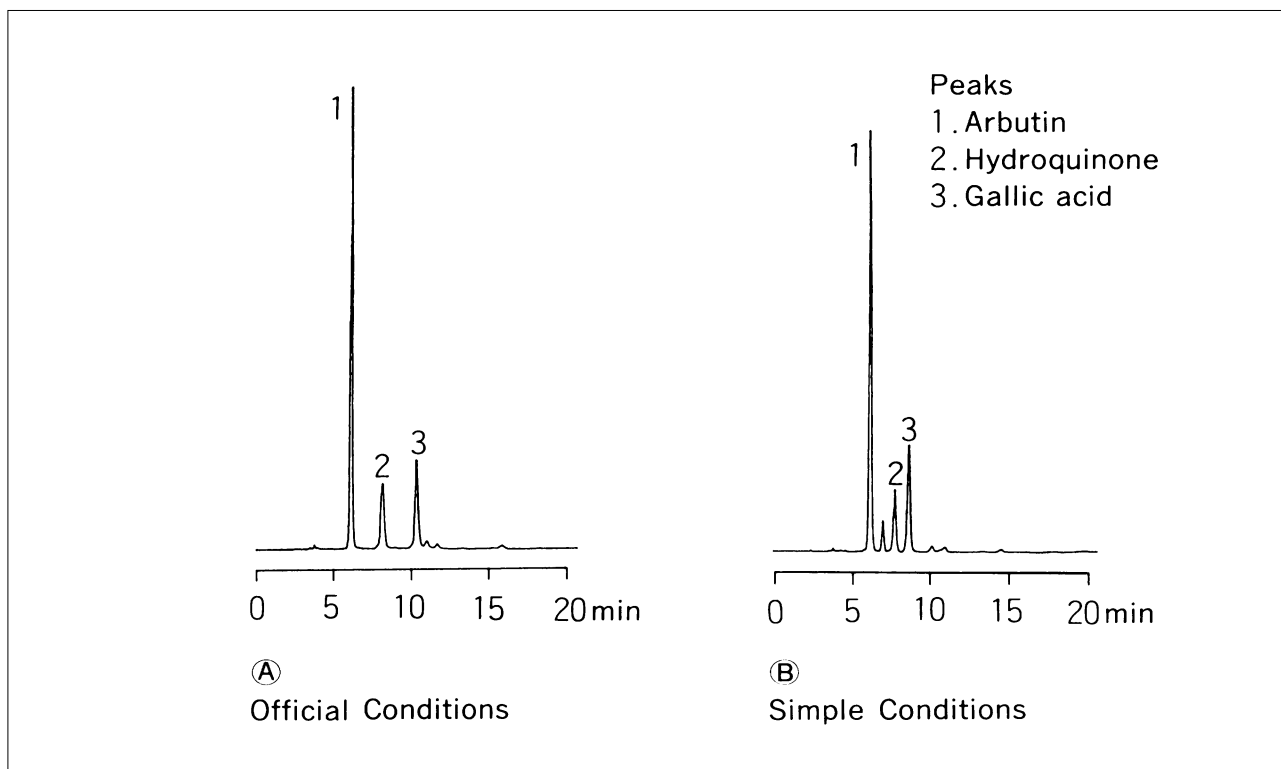
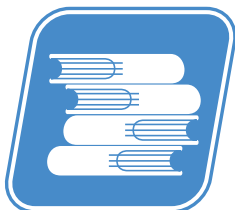

Fig. 3.6.3 Analysis of arbutin in bearberry powder



4. Clinical and Forensic Medicine

4.1 Microanalysis of Cyanogens in Blood - GC

•Explanation

Cyanogen gas is generated by combustion of certain macromolecular construction materials, etc., and the amount of cyanogen gas together with carbon monoxide in blood have to be measured in fire fatalities. Methods such as the pyridine-pyrazolone method and electrode method are used for cyanogen gas but the headspace GC (FTD) method is the easiest and fastest way of analyzing cyanogens in blood. This data introduces analysis examples conforming to the Pharmaceutical Society of Japan's toxic drug chemical testing method (see reference contributions 1 to 4).

•Pretreatment

- Seal 0.5mL blood sample + 3mL distilled water in 8mL vial (screw lid with packing).
↓
- Add 2mL 50% phosphate (for quantitative analysis of physiological concentration level, 30 μ L of 1mol/L ascorbic acid is added, as it is preferable to prevent interference by thiocyanic acid that exists in blood; see reference contribution 5).
↓
- After mixing keep at constant temperature of 50°C for 30 min.
↓
- Inject 0.5mL gas-state sample into GC using gas-tight syringe heated to 50°C.

•Analytical Conditions

Instrument	: GC-17A AWFwFt
Column	: DB-GSQ 30m \times 0.53mm i.d.
Col.Temp.	: 130°C
Inj.Temp.	: 200°C
Det.Temp.	: 250°C (FTD)
Carrier Gas	: He 7mL/min
Injection	: Direct

References

1. Yasuo Seto: "Headspace Gas Chromatography Method in Legal Toxicology", No. 3 of volume 12 Regal Toxicology, published in 1994 (separate volume) introduction
2. Manabu Furuta, Toshimitsu Watahiki, Tetsuo Ishida: "Quantitative Method for Cyanogen Compounds with FTD", Japanese Medical Journal 43(2), 179-185, 1989
3. Toshiaki Shinohara, Yasuo Seto: "Quantitative Methods for Micro Amounts of Cyanogen in Blood using Headspace Gas Chromatography - Comparisons with Pyridine-Pyrazolone Method", National Research Institute of Police Science Report Vol. 40, No. 3, August 1987
4. The Pharmaceutical Society of Japan 115th Meeting, Public Health Conference Material (p 76), Toxic Drug Chemical Test Method, Cyanogen Compound Test Method
5. Yasuo Seto, Jpn.J. Toxicol. Environ. Health., Vol. 42, 319-325 (1996)

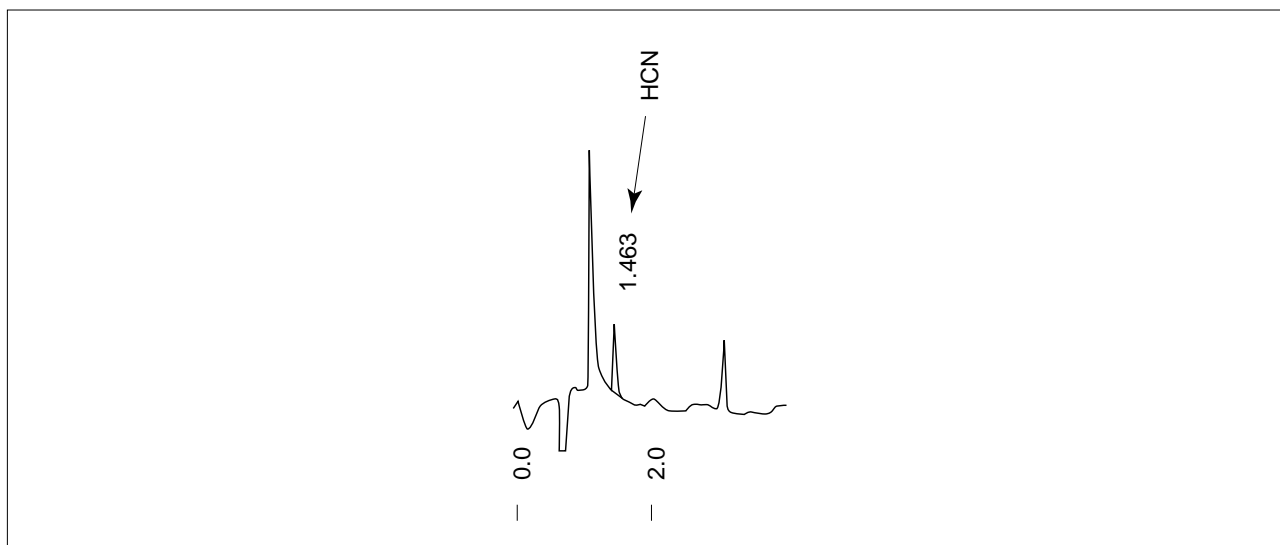
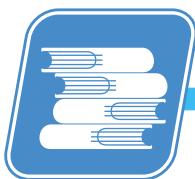

Fig. 4.1.1 Chromatogram of Cyanogen in blood (5ng/mL)



4.2 Analysis of Antiarrhythmic Drug (1) - GC

•Explanation

This introduces data of analyzed antiarrhythmic drug in blood serum.

•Pretreatment

See Fig. 4.2.2 (pretreatment flowchart) for details.

•Analytical Conditions

Instrument	: GC-14BPSi
Column	: CBP5 25m × 0.22mm i.d. df=0.25μm
Col.Temp.	: 260°C
Inj.Temp.	: 300°C
Det.Temp.	: 300°C (SID)
Carrier Gas	: He 2.0mL/min
Injection	: Split 1 : 2 (Solventless)

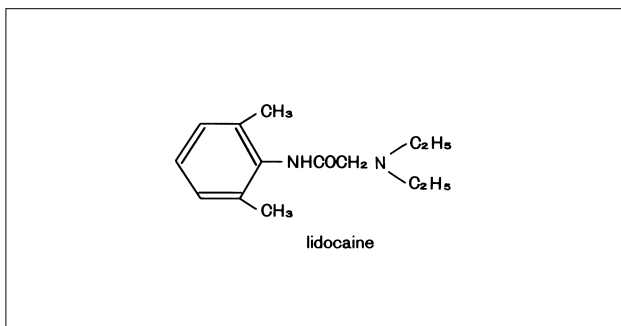

Fig. 4.2.1 Structural Formula: Structural formula of lidocaine

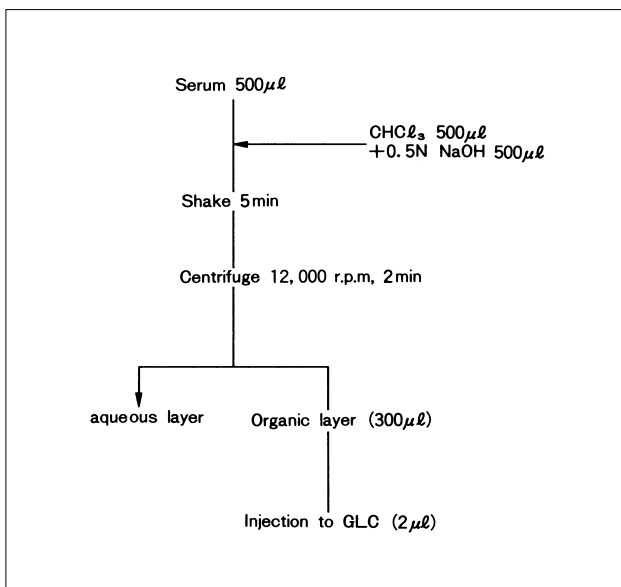

Fig. 4.2.2 Pretreatment flowchart for lidocaine in blood serum

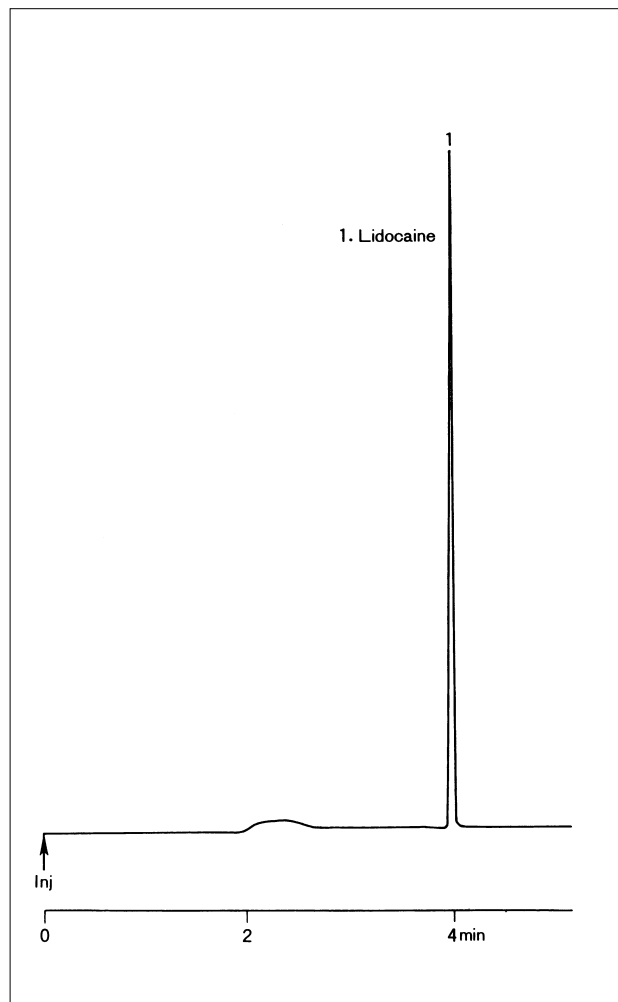

Fig. 4.2.3 Chromatogram of lidocaine in blood serum

4.2 Analysis of Antiarrhythmic Drug (2) - GC

•Explanation

This introduces data of analyzed antiarrhythmic drug in plasma.

•Pretreatment

See Fig. 4.2.2 (pretreatment flowchart) for details.

•Analytical Conditions

Instrument : GC-14BPSi
 Column : CBP5 25m × 0.22mm i.d.
 df=0.25μm
 Col.Temp. : 260°C
 Inj.Temp. : 300°C
 Det.Temp. : 300°C(SID)
 Carrier Gas : He 2.0mL/min
 Injection : Split 1 : 2 (Solventless)

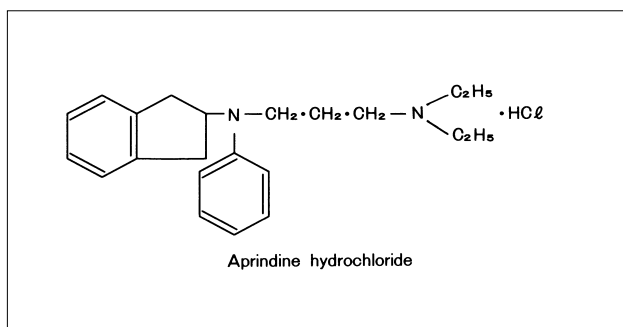

Fig. 4.2.1 Structural Formula: Structural formula of aprindine hydrochloride

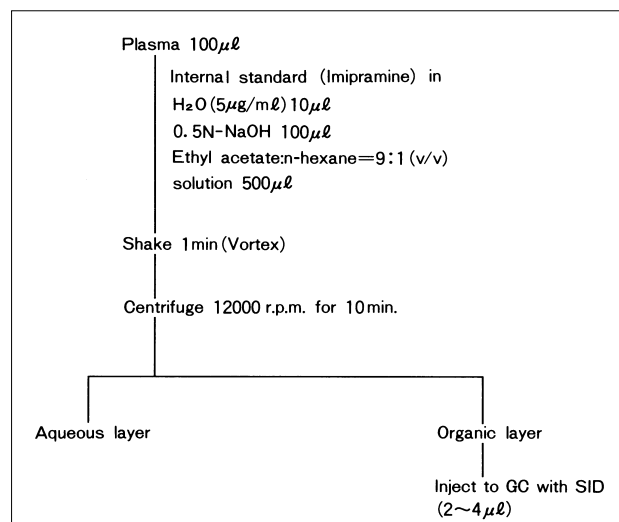

Fig. 4.2.2 Pretreatment flowchart for aprindine hydrochloride in plasma

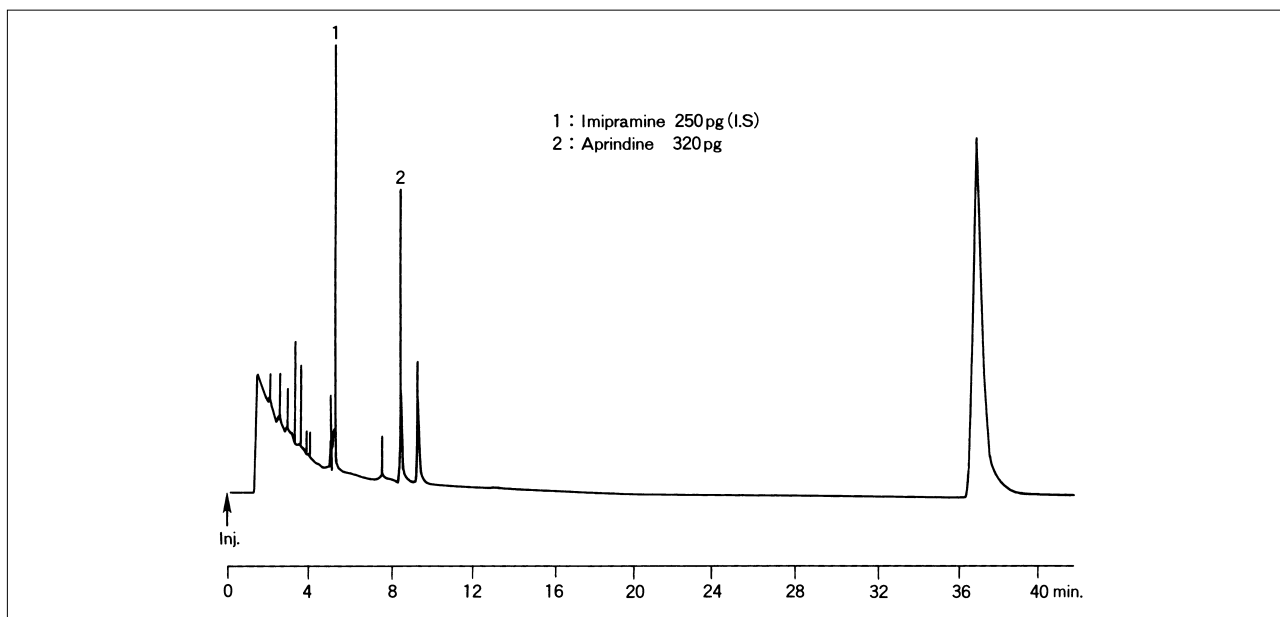
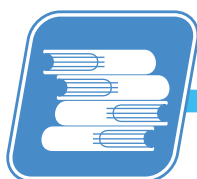

Fig. 4.2.3 Chromatogram of aprindine hydrochloride in plasma



4.3 Analysis of Psychotropic Agent Chlorpromazine (1) - GC

•Explanation

The psychotropic agent chlorpromazine (CPZ) is widely used as an anti-psychotic agent, but the effective concentration in blood is extremely low, so selective high-sensitivity analysis is required. This data introduces analysis examples of chlorpromazine in blood serum.

•Pretreatment

See Fig. 4.3.2 (pretreatment flowchart) for details.

•Analytical Conditions

Instrument	: GC-14BPSi
Column	: CBP1 25m × 0.33mm i.d. df=0.50μm
Col.Temp.	: 70°C(2min) – 10°C/min – 280°C(20min)
Inj.Temp.	: 320°C
Det.Temp.	: 320°C (SID)
Carrier Gas	: He 2.9mL/min
Injection	: Splitless (Sampling Time : 1min)

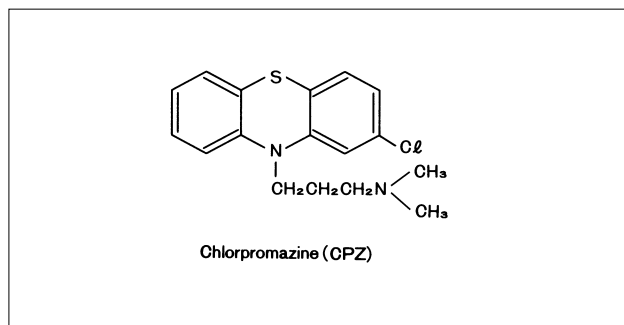

Fig. 4.3.1 Structural formula of chlorpromazine (CPZ)

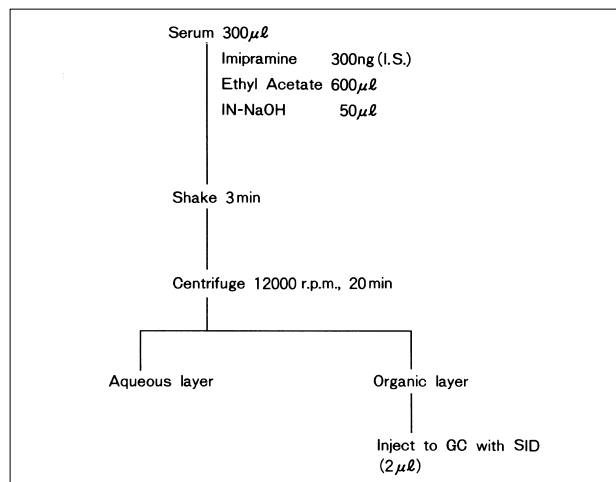

Fig. 4.3.2 Pretreatment flowchart example for chlorpromazine in blood serum

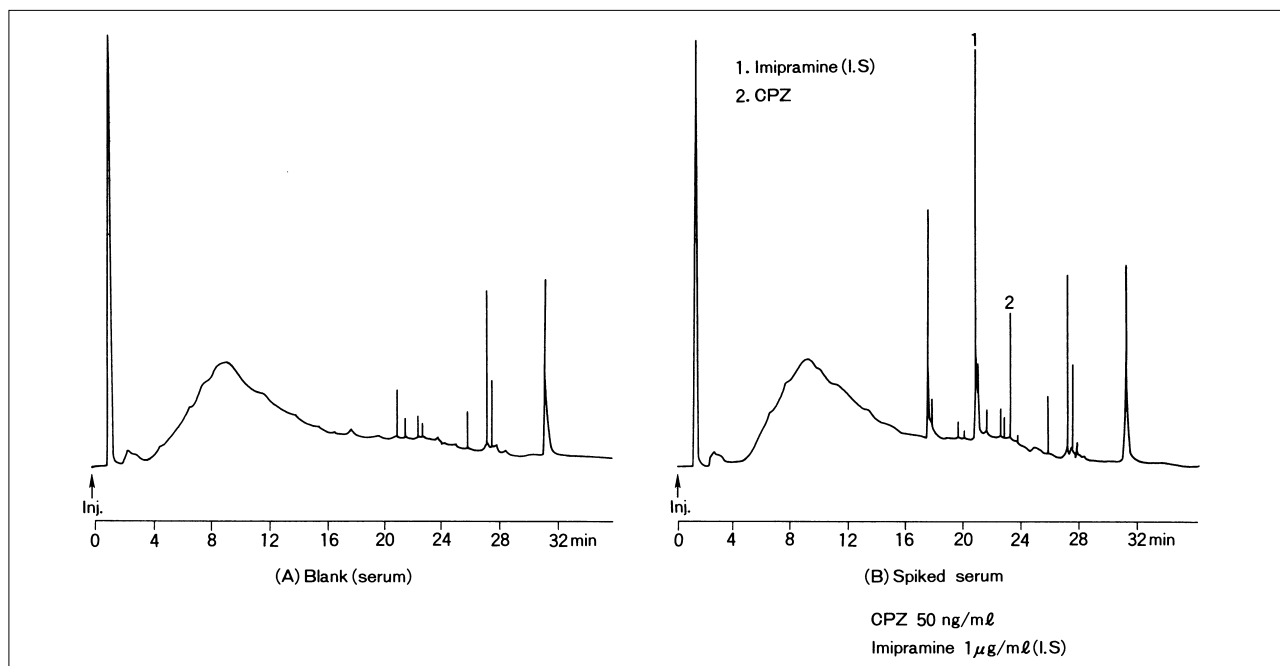

Fig. 4.3.3 Chromatogram of chlorpromazine in blood serum

4.3 Analysis of Psychotropic Agent Chlorpromazine (2) - GC

•Explanation

The following data shows sensitivity comparisons of analysis results for individual detection by FID, FTD, ECD and SID used to analyze in-blood concentration of chlorpromazine (CPZ), a substance widely used as an anti-psychotic agent.

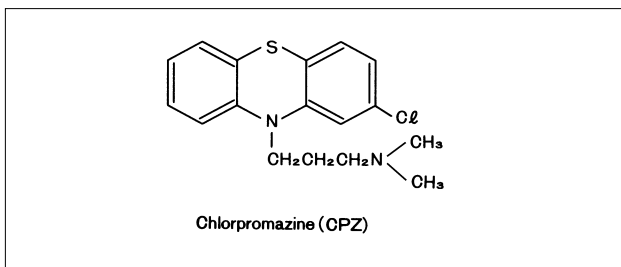

Fig. 4.3.1 Structural formula: Structural formula of chlorpromazine

•Pretreatment

Blood serum is extracted using ethyl acetate and 1 μ L injected.

•Analytical Conditions

Instrument (Base) : GC-14BPFsc

Column : CBP-1 25m \times 0.33mm i.d.
df=0.50 μ m

Col.Temp. : 70°C(1min) – 10°C/min – 280°C

Inj.Temp. : 320°C

Det.Temp. : 320°C (FID, FTD, ECD, SID)

Carrier Gas : He 2.9mL/min

Injection : Splitless (Sampling Time : 1min)

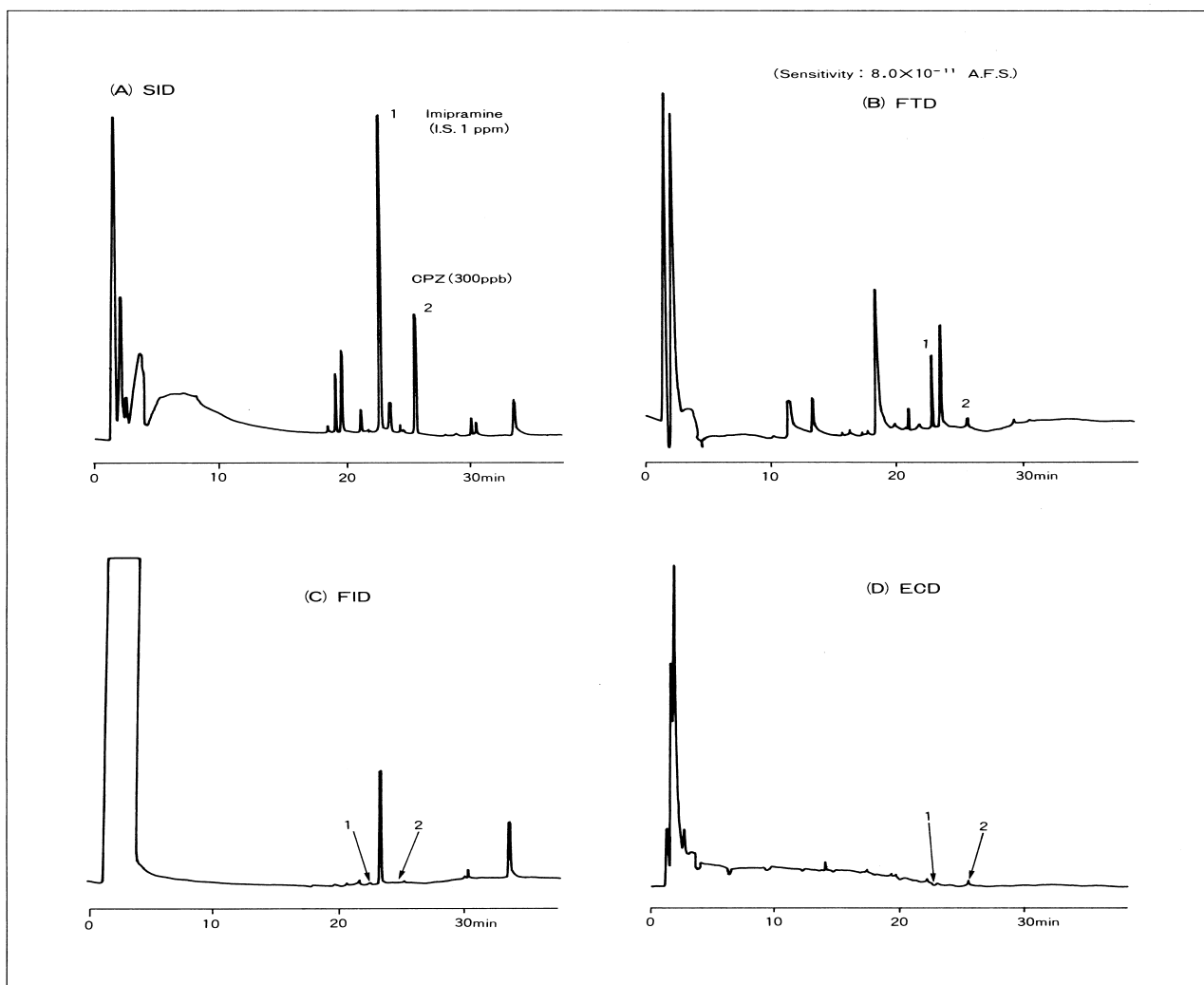
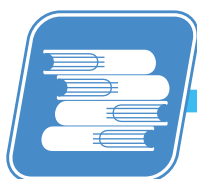

Fig. 4.3.2 Chromatograms of chlorpromazine in blood serum using each type of detector



4.4 Analysis of Psychotropic Agent Haloperidol - GC

•Explanation

Haloperidol is widely used as a treatment drug for schizophrenia and depression, but the effective concentration in blood is extremely low, so selective high-sensitivity analysis is required. This data introduces analysis examples of haloperidol in blood serum.

•Pretreatment

See Fig. 4.4.2 (pretreatment flowchart) for details.

•Analytical Conditions

Instrument	: GC-14BPSi
Column	: DB-1 30m × 0.32mm i.d. df=0.50μm
Col.Temp.	: 300°C
Inj.Temp.	: 320°C
Det.Temp.	: 320°C (SID)
Carrier Gas	: He 3.4mL/min
Injection	: Split 1 : 1.4 (Solventless)

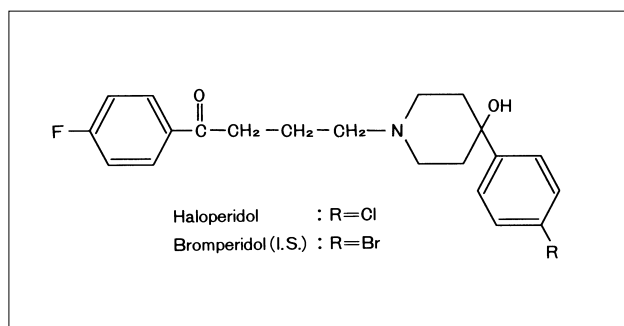

Fig. 4.4.1 Structural formula of haloperidol and bromperidol

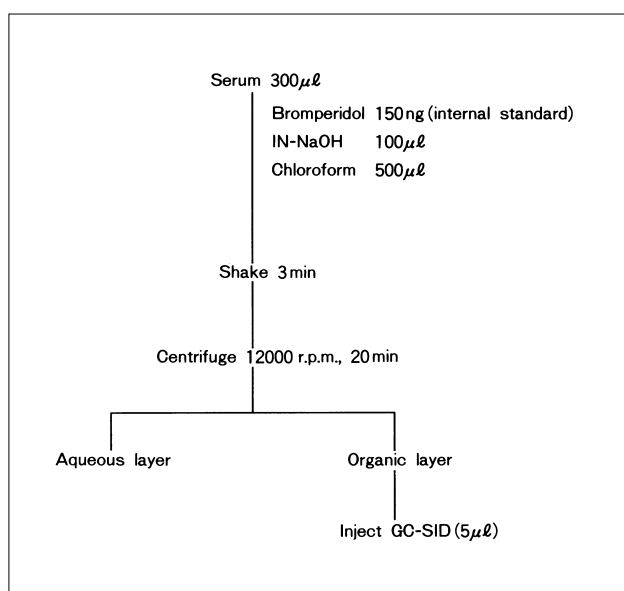

Fig. 4.4.2 Pretreatment flowchart for haloperidol in blood serum

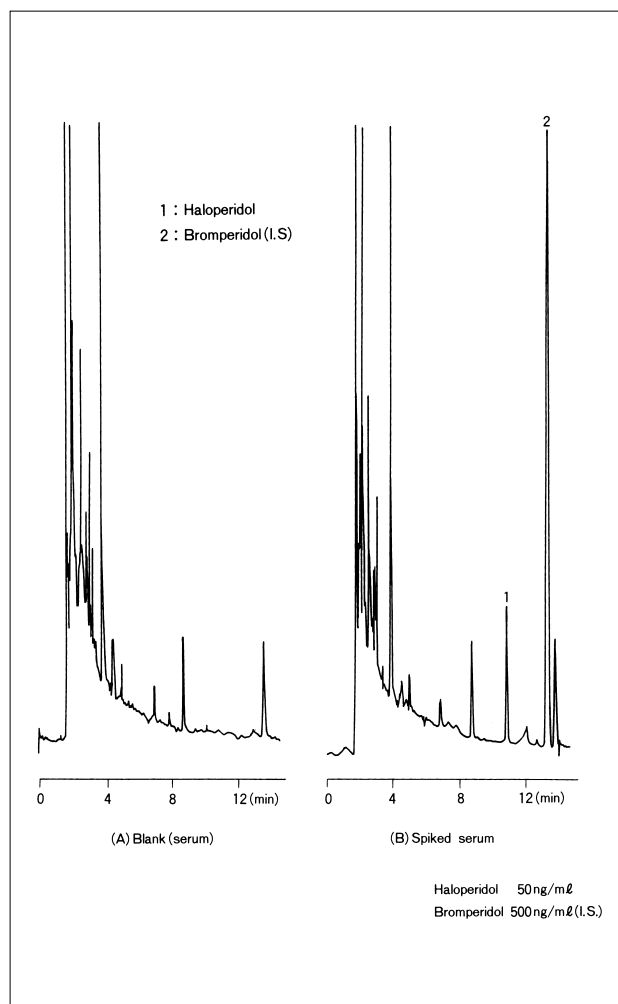

Fig. 4.4.3 Chromatograms of haloperidol and bromperidol in blood serum

4.5 Analysis of Psychotropic Agent Imipramine and its Metabolic Substance - GC

•Explanation

This data introduces analysis of anti-psychotropic agent imipramine, which is greatly used in clinical medicine, and its metabolic substance desipramine that is pharmacologically active.

•Pretreatment

See Fig. 4.5.2 (pretreatment flowchart) for details.

•Analytical Conditions

Instrument : GC-14BPSi
Column : CBP1 25m × 0.33mm i.d.
df=0.50μm
Col.Temp. : 250°C
Inj.Temp. : 300°C
Det.Temp. : 300°C (SID)
Carrier Gas : He 4.0mL/min
Injection : Split 1 : 2 (Solventless)

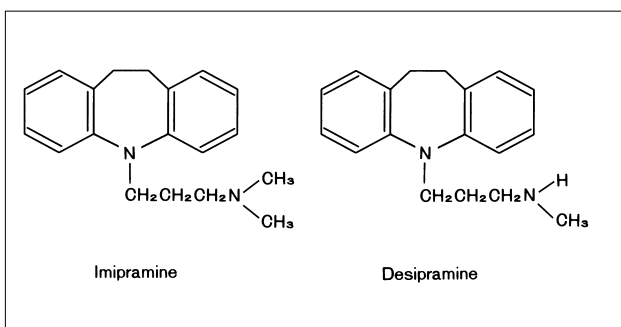

Fig. 4.5.1 Structural formula: Structural formula of imipramine and desipramine

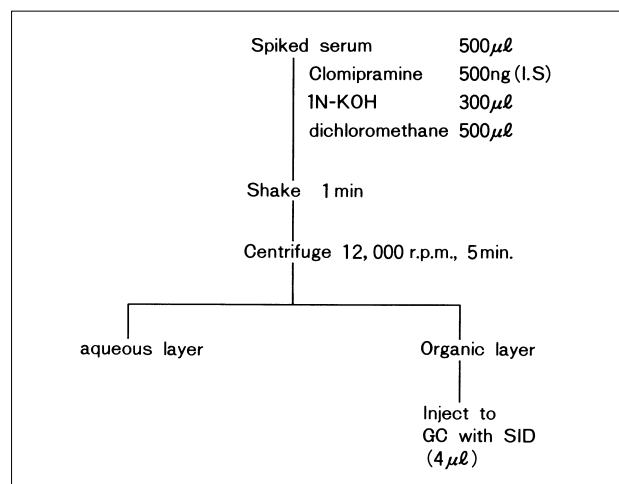

Fig. 4.5.2 Pretreatment flowchart for imipramine in blood serum

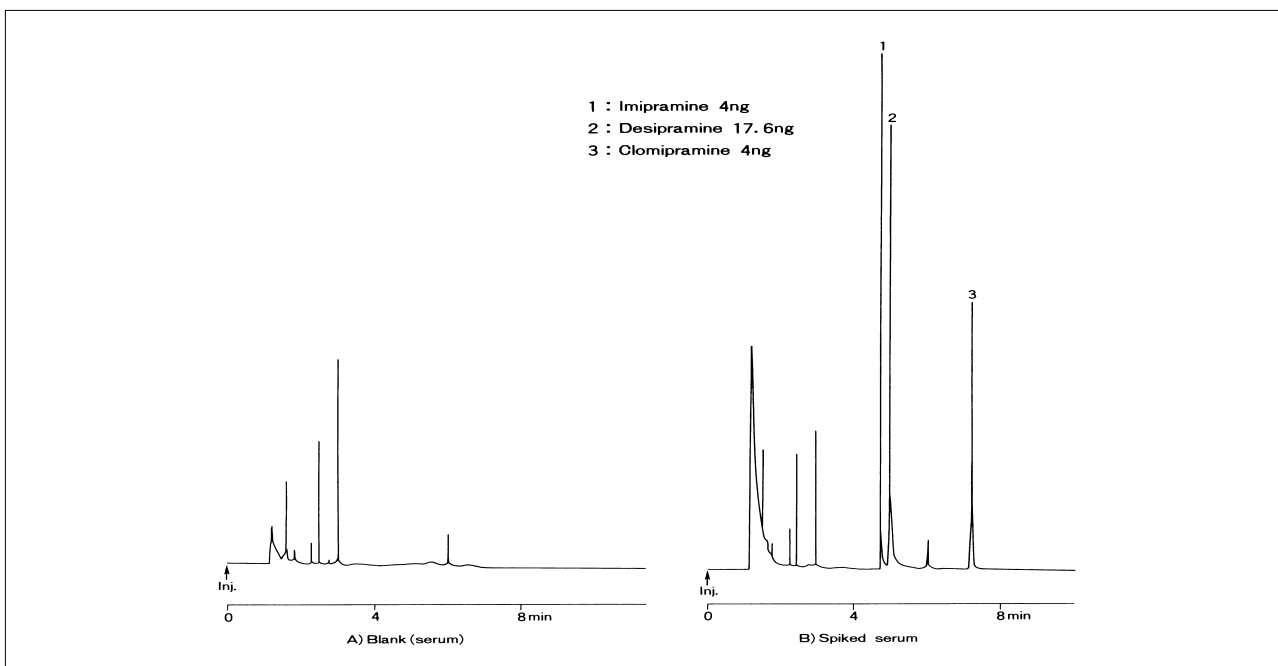
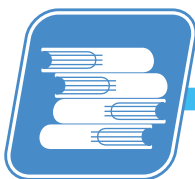

Fig. 4.5.3 Chromatogram of imipramine and desipramine in blood serum



4.6 Analysis of Stimulant Drugs Using GC/MS - GCMS

•Explanation

Urine samples of people suspected of using stimulant drugs are analyzed to detect the drug. The following are substances targeted by the Stimulant Control Law.

- (1) Phenyl-aminopropane, phenyl-methyl-aminopropane and other salts of this kind
- (2) Material specified by laws as being active stimulants
- (3) Substances that contain any material covered by item and above, which are shown in Fig. 4.6.1.

The handling of these compounds is strictly regulated making them difficult to obtain, so a similar compounds with weak stimulant effects were analyzed as TFA (trifluoroacetyl) derivatives using the EI method and CI method (Fig. 4.6.2).

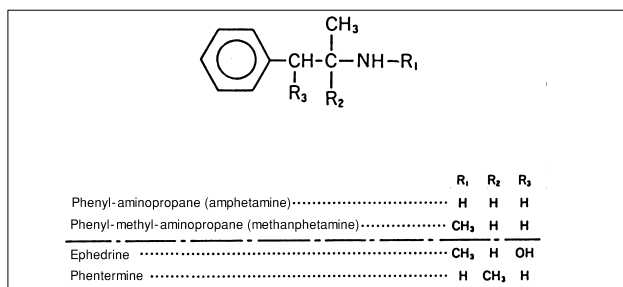

Fig. 4.6.1 Structural formula of stimulant drug

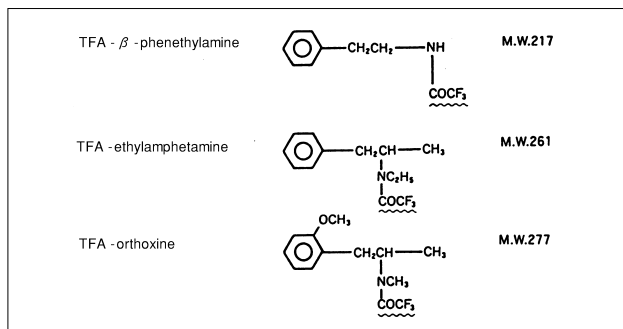

Fig. 4.6.2 Structural formulas of compounds similar to stimulant drug used for analysis

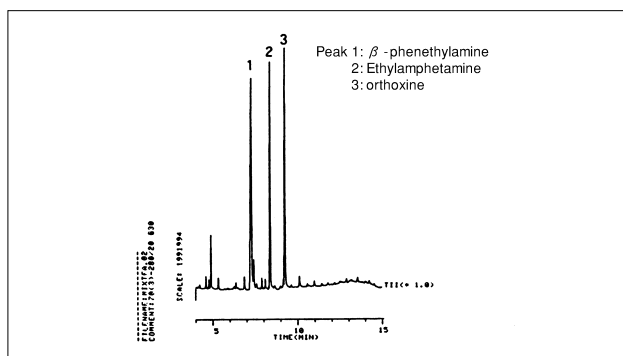

Fig. 4.6.3 TIC of TFA derivatives of stimulant drug dummy compounds

•Analytical Conditions

Instrument	: GCMS-QP1000
- GC -	
Column	: CBP-5 (25m × 0.22mm i.d. df=0.25μm)
Column Temp.	: 70°C(3min) - 20°C/min - 230°C(3min)
Injector Temp.	: 250°C
Carrier gas	: He 100kPa
Injection Method	: Splitless (Sampling Time=2min)
Injection Volume	: 2μL
- MS -	
Interface Temp.	: 250°C
Ion Source Temp.	: 250°C
Ionization Method	: EI/CI (Reaction gas: isobutane)
Scan Range	: m/z 35-700(EI) m/z 100-700(CI)
Scan Interval	: 2sec

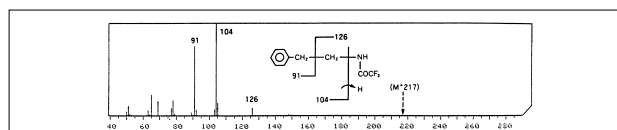

Fig. 4.6.4 EI mass spectrum of peak 1 (β-phenethylamine)

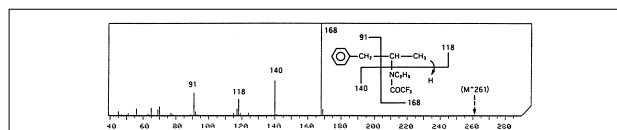

Fig. 4.6.5 EI mass spectrum of peak 2 (ethylamphetamine)

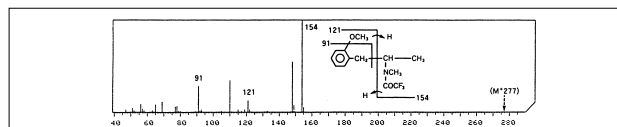

Fig. 4.6.6 EI mass spectrum of peak 3 (orthoxine)

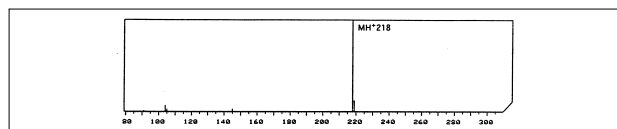

Fig. 4.6.7 CI mass spectrum of peak 1 (β-phenethylamine)

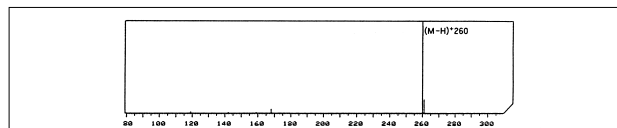

Fig. 4.6.8 CI mass spectrum of peak 2 (ethylamphetamine)

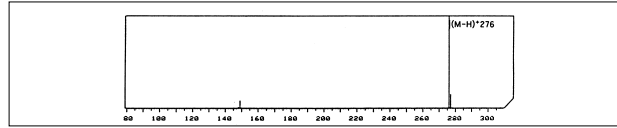

Fig. 4.6.9 CI mass spectrum of peak 3 (orthoxine)

4.7 Mass Screening of Congenital Metabolic Disorder (Phenylketonuria) (1) - GCMS

•Explanation

With mass screening of congenital metabolic disorder, GC/MS identifies and quantifies ground substances and erroneous metabolic elements that have accumulated due to a disorder in a certain metabolic route in order to locate the metabolic region and enable diagnosis of the disease. Phenylketonuria is an ailment where the symptoms - including central nervous disorders such as intellectual impairment, convulsions and brain wave errors, and melamine achromia - are determined from the latter half of infancy.

Fig. 4.7.1 shows the metabolic route of phenylalanine. As Fig. 4.7.2 shows, phenylketonuria can be diagnosed if phenylpyruvic acid, phenyllactic acid and phenylalanine can be found in the urine sample.

•Analytical Conditions

Instrument	: GCMS-QP5000
- GC -	
Column	: DB-5(30m × 0.25mm.i.d. df=0.25µm)
Column Temp.	: 60°C – 17°C/min – 325°C(3min)
Injector Temp.	: 260°C
Carrier gas	: He 50kPa
Injection Method	: Split (20:1)
- MS -	
Interface Temp.	: 280°C
Ionization Method	: EI
Scan Range	: m/z 50-650(EI)
Scan Interval	: 0.4sec

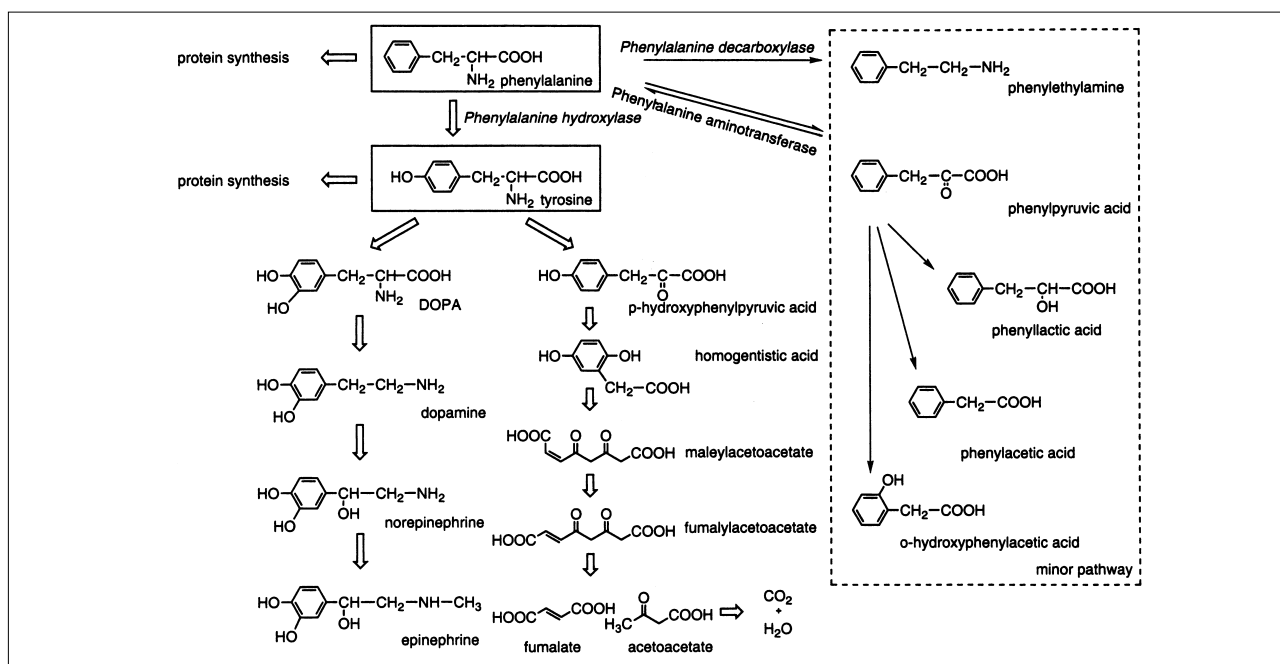

Fig. 4.7.1 Phenylalanine metabolic route

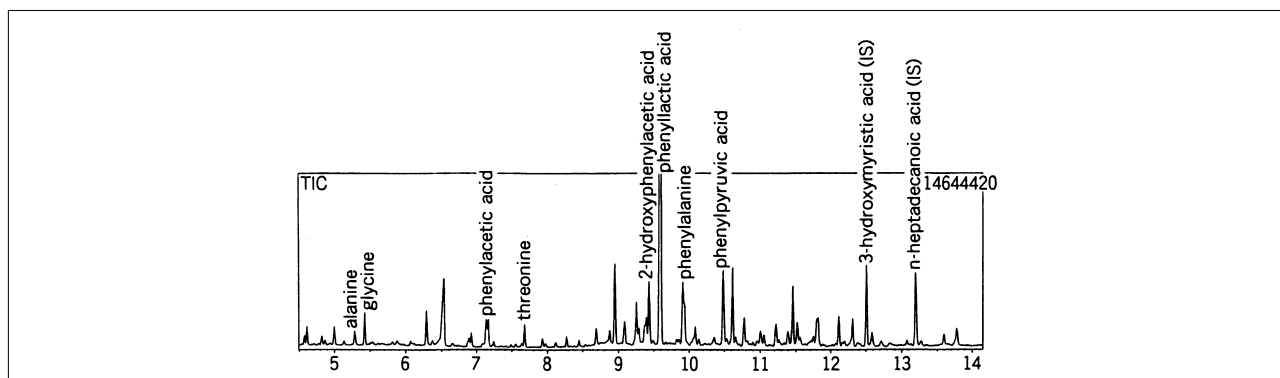
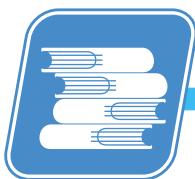

Fig. 4.7.2 Total ion chromatogram of urine from a phenylketonuria patient



4.7 Mass Screening of Congenital Metabolic Disorder (Propionic Acidemia and Methylmalonic Acidemia) (2) - GCMS

•Explanation

With mass screening of congenital metabolic disorder, GC/MS identifies and quantifies ground substances and erroneous metabolic elements that have accumulated due to a disorder in a certain metabolic route in order to locate the metabolic region and enable diagnosis of the disease. Propionic acidemia and methylmalonic acidemia is recognized by symptoms such as vomiting, lethargy, myotony reduction and growth retardation.

Fig. 4.7.3 shows the metabolic route of isoleucine. As Fig. 4.7.4 shows, propionic acidemia can be diagnosed if 3-hydroxyisovaleric acid, tiglylglycine and methylcitric acid can be found in the urine sample. As Fig. 4.7.5 shows, methylmalonic acidemia can be diagnosed if methylmalonic acid and 3-hydroxypropionic as a micro metabolic substance can be found in the urine sample.

•Analytical Conditions

Instrument	: GCMS-QP5000
– GC –	
Column	: DB-5(30m × 0.25mm.i.d. df=0.25µm)
Column Temp.	: 60°C – 17°C/min – 325°C(3min)
Injector Temp.	: 260°C
Carrier gas	: He 50kPa
Injection Method	: Split (20:1)
– MS –	
Interface Temp.	: 280°C
Ionization Method	: EI
Scan Range	: m/z 50-650 (EI)
Scan Interval	: 0.4sec

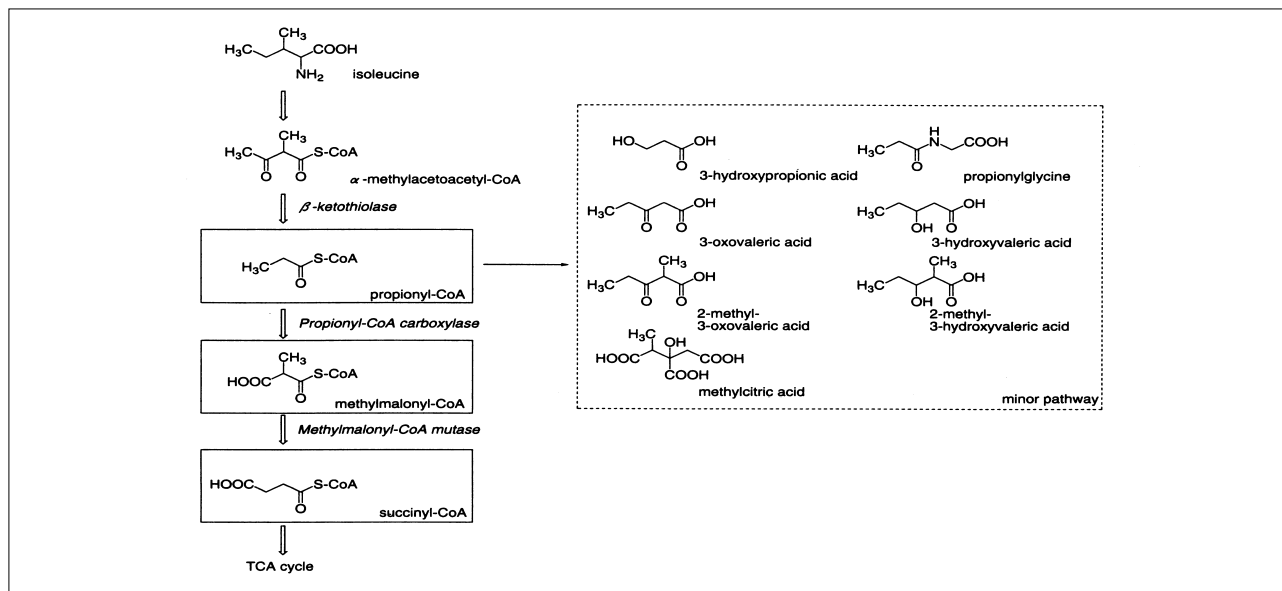

Fig. 4.7.3 Isoleucine metabolic route

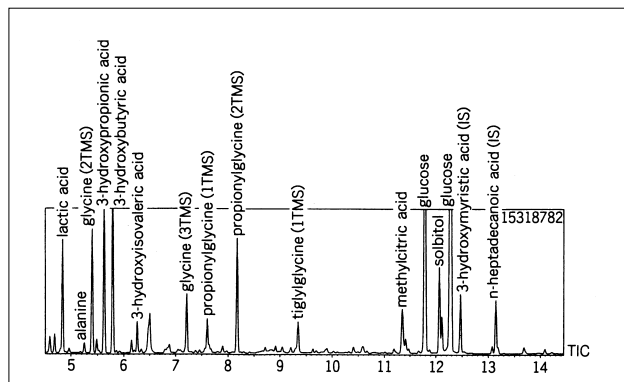

Fig. 4.7.4 Total ion chromatogram of urine from a propionic acidemia patient

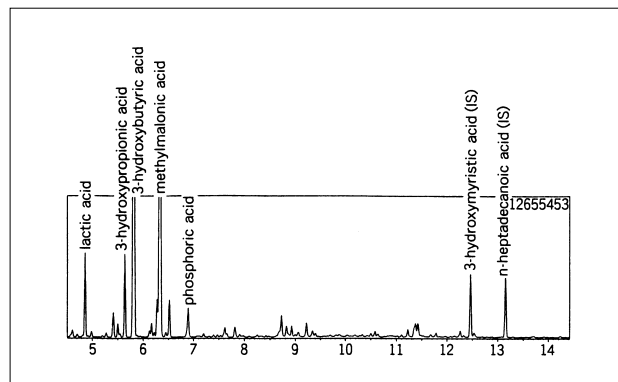

Fig. 4.7.5 Total ion chromatogram of urine from a methylmalonic acidemia patient

4.7 Mass Screening of Congenital Metabolic Disorder (Isovaleric Acidemia) (3) - GCMS

•Explanation

With mass screening of congenital metabolic disorder, GC/MS identifies and quantifies ground substances and erroneous metabolic elements that have accumulated due to a disorder in a certain metabolic route in order to locate the metabolic region and enable diagnosis of the disease. Isovaleric acidemia is an ailment with symptoms including the generation of an odor that smells like "sweaty feet", polypnea, vomiting and lowering of consciousness. This ailment can lead to death if untreated.

Fig. 4.7.6 shows the metabolic route for leucine. As shown in Fig. 4.7.7, isovalerylglucine and 3-hydroxyisovaleric acid can be found in the urine sample.

•Analytical Conditions

Instrument	: GCMS-QP5000
– GC –	
Column	: DB-5(30m × 0.25mm.i.d. df=0.25µm)
Column Temp.	: 60°C – 17°C/min – 325°C(3min)
Injector Temp.	: 260°C
Carrier gas	: He 50kPa
Injection Method	: Split (20:1)
– MS –	
Interface Temp.	: 280°C
Ionization Method	: EI
Scan Range	: m/z 50-650 (EI)
Scan Interval	: 0.4sec

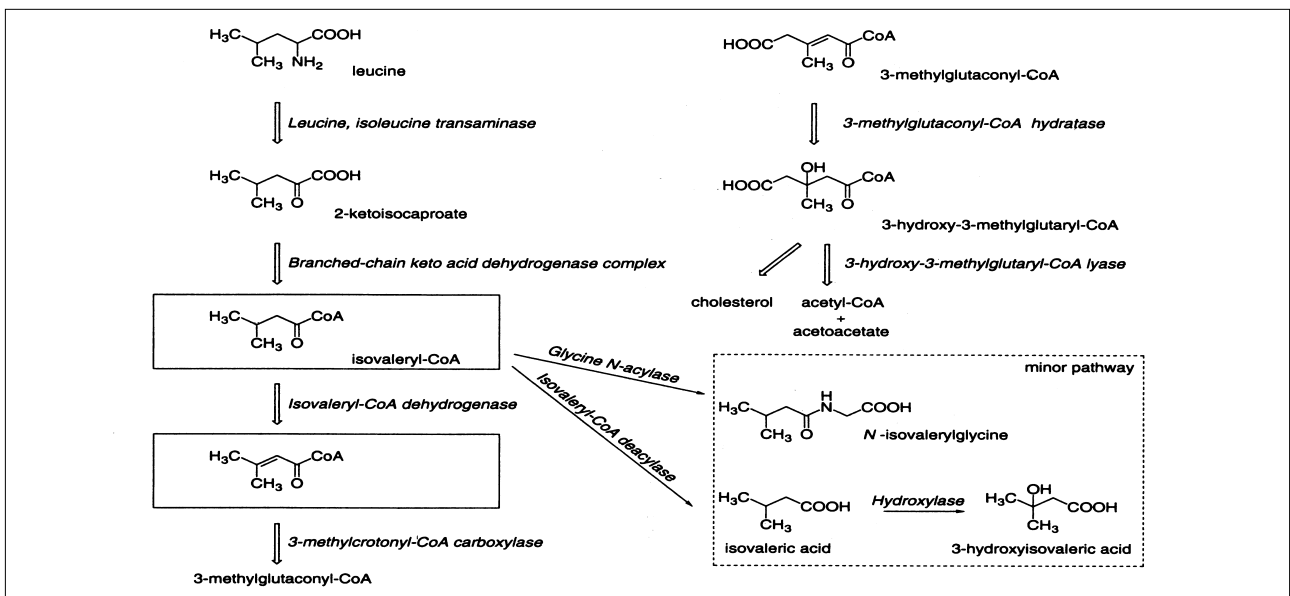

Fig. 4.7.6 Leucine metabolic route

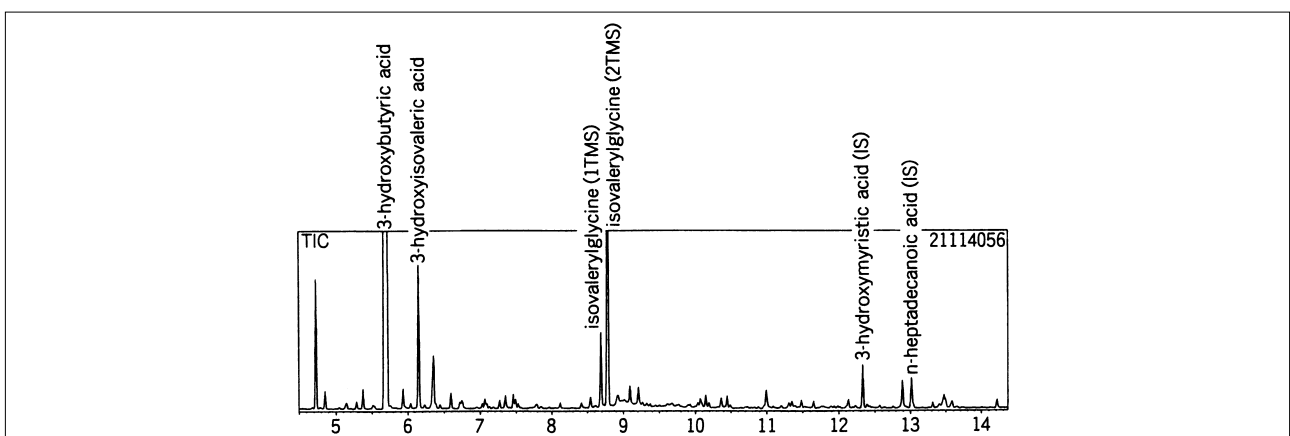
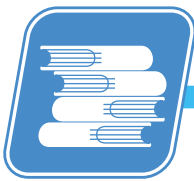

Fig. 4.7.7 Total ion chromatogram of urine from isovaleric acidemia patient



4.8 Emergency Testing Method for Acute Drug Overdose using DI/CI/MS - GCMS

•Explanation

With mass spectrometry using direct sample introduction (DI), the analysis of mixed samples is difficult because the GC separation stage is not used, but it is effective for analysis of compounds that easily heat decompose and compounds with high boiling points. If the compound has been purified in advance, the structure can be confirmed quickly without having to make a derivative of it, as is the case with GC.

The structure and molecular weight of such a compound can be confirmed using a combination of electron-impact ionization (EI) and chemical ionization (PCI) methods.

•Analytical Conditions

Instrument : GCMS-QP1000 (with PCI/DI) – MS –

Ionization Box Temp. : 250°C (EI), 200°C (PCI)

Ionization Method : EI/CI (Reaction gas: Isobutane)

Scan Range : m/z 35-450 (EI)
m/z 70-450 (PCI)

Scan Interval : 2sec

DI Temp. : 40°C – 40°C/min-270°C (10min)

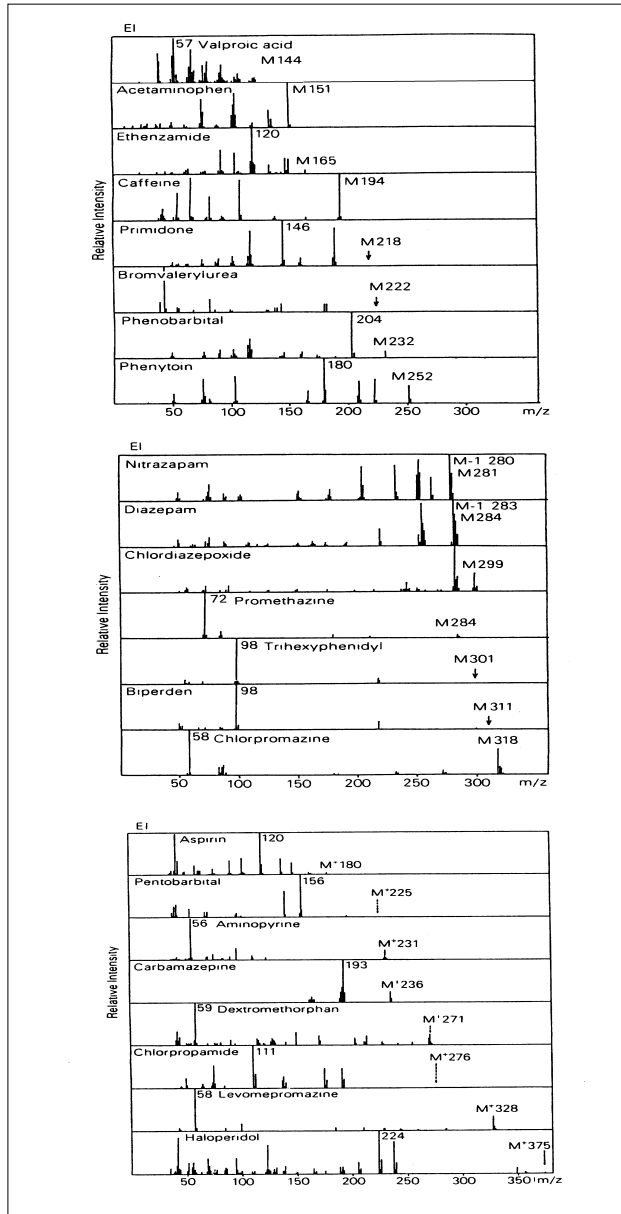

Fig. 4.8.1 EI spectrum of standard drug

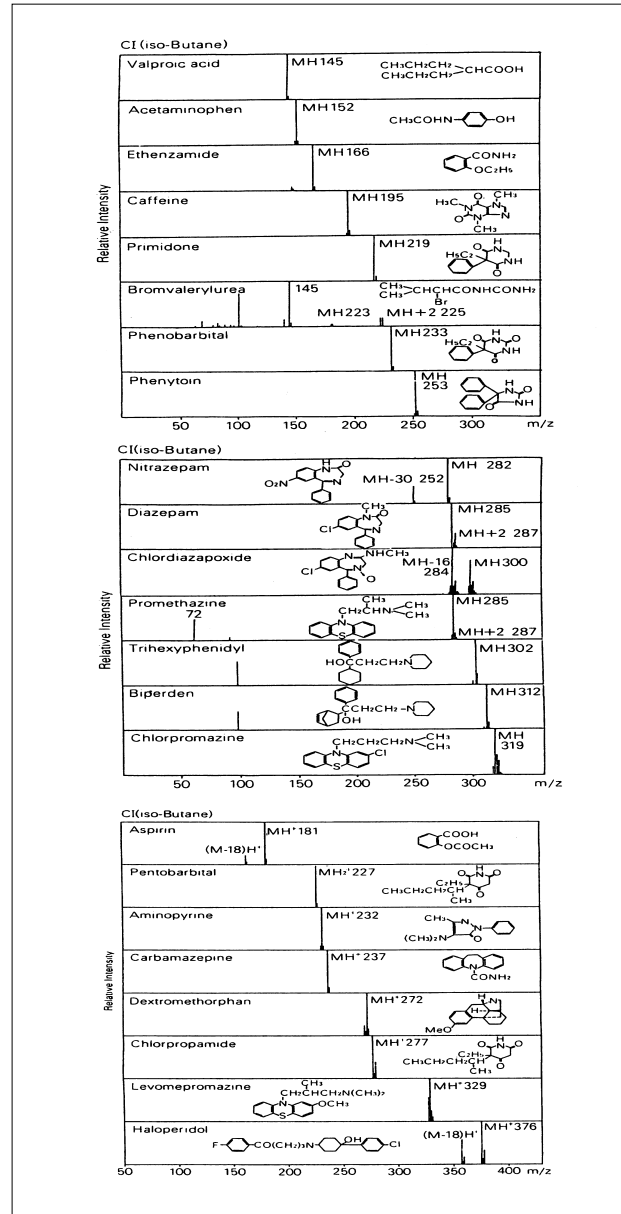

Fig. 4.8.2 CI spectrum of standard drug

4.9 Analysis of Drugs Using Fast-GC/MS (1) - GCMS

•Explanation

Demands are being placed on analysis laboratories to shorten analysis time and increase productivity in analysis with a higher throughput of samples at a lower cost. Fast-GC/MS uses as a column with slender inner diameter to realize high separation and, what is more, analysis time can be shortened without sacrificing separation. Fig. 4.9.1 shows analysis results for 0.1 μ L standard sample analyzed at 1:80 split ratio. This would have required approximately 14 min with a conventional analysis column but Fast-GC/MS analyzed this sample in 3 min. Fig. 4.9.2 shows the analysis results of a typical drug.

•Analytical Conditions

Instrument : GCMS-QP5050A(Fast-GC/MS type)
– GC –
Column : CP-SIL5(10m \times 0.10mm i.d. df=0.12 μ m)
Column Temp. : 80°C(1min) – 40°C/min – 320°C(5min)
Injector Temp. : 280°C
Carrier gas : He 500kPa
Injection Method : Split (80:1)
Injection Volume : 0.1 μ L
– MS –
Interface Temp. : 320°C
Ionization Method : EI
Scan Range : m/z 55-499
Scan Interval : 0.1sec

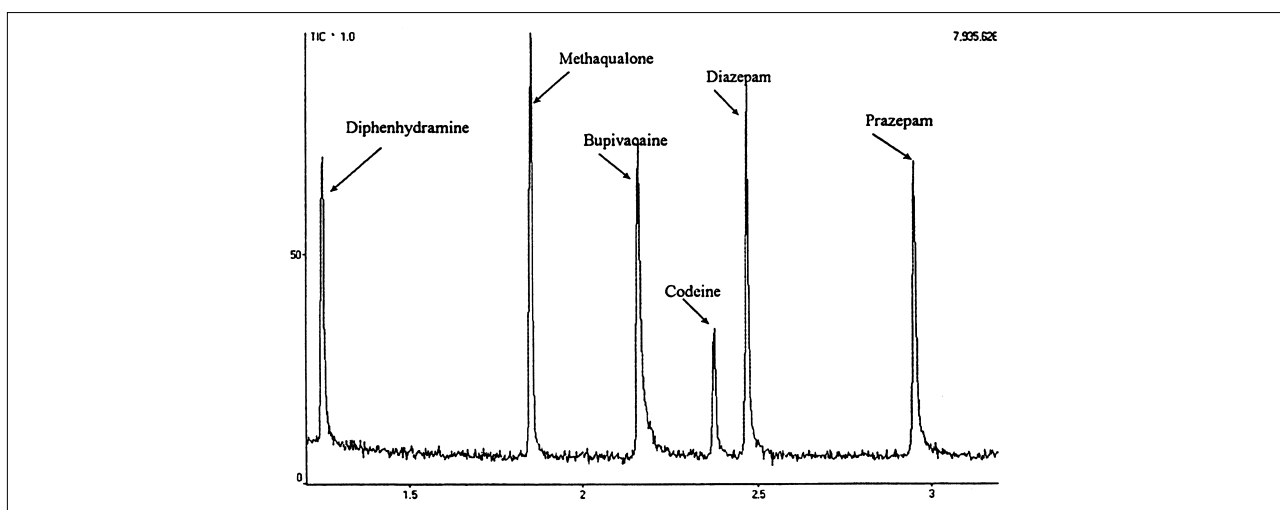

Fig. 4.9.1 Total ion chromatogram of standard sample analyzed using Fast-GC/MS

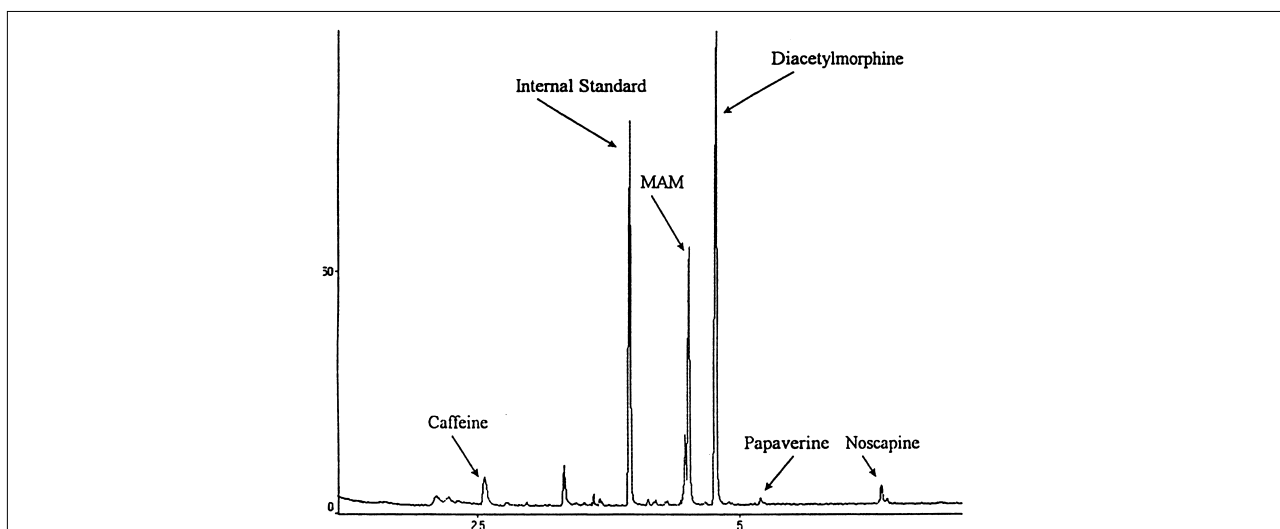
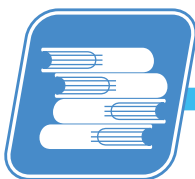

Fig. 4.9.2 Total ion chromatogram of typical drug analyzed using Fast-GC/MS



4.9 Analysis of Drugs Using Fast-GC/MS (2) - GCMS

•Explanation

Demands are being placed on analysis laboratories to shorten analysis time and increase productivity in analysis with a higher throughput of samples at a lower cost. Fast-GC/MS uses a column with slender inner diameter to realize high separation and, what is more, analysis time can be shortened without sacrificing separation. Fig. 4.9.3 shows a comparison of total ion chromatograms from measurements of drug in urine made using Fast-GC/MS and conventional GC/MS methods. Fig. 4.9.4 shows a mass chromatogram from results of measurement of drug in urine using Fast-GC/MS.

Injector Temp.	: 280°C
Carrier gas	: He
– Normal GC –	
Column	: DB-5MS (30m × 0.25mm i.d. df=0.25µm)
Column Temp.	: 70°C (2min) – 20°C/min – 200°C – 7°C/min – 300°C (3min) min – 25°C/min – 320°C (2.5min)
Injection Method	: Splitless (Sampling time=1min)
Injection Volume	: 1µL
Injector Temp.	: 280°C
Carrier gas	: He
– MS –	
Interface Temp.	: 320°C
Ionization Method	: EI
Scan Range	: m/z 55-499
Scan Interval	: 0.1sec

•Analytical Conditions

Instrument	: GCMS-QP5050A
– Fast GC –	
Column	: CP-SIL5 (10m × 0.10mm i.d. df=0.12µm)
Column Temp.	: 80°C (1min) – 40°C/min – 320°C (5min)
Injection Method	: Splitless (Sampling time=0.5min)
Injection Volume	: 0.5µL

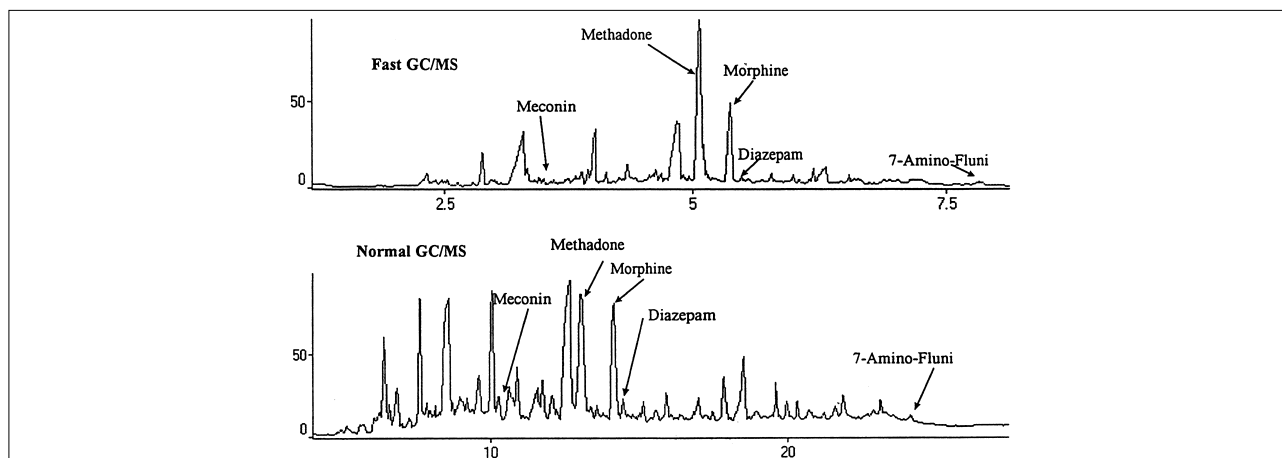

Fig. 4.9.3 Total ion chromatogram of drug in urine (upper: Fast-GC/MS, lower: conventional GC/MS)

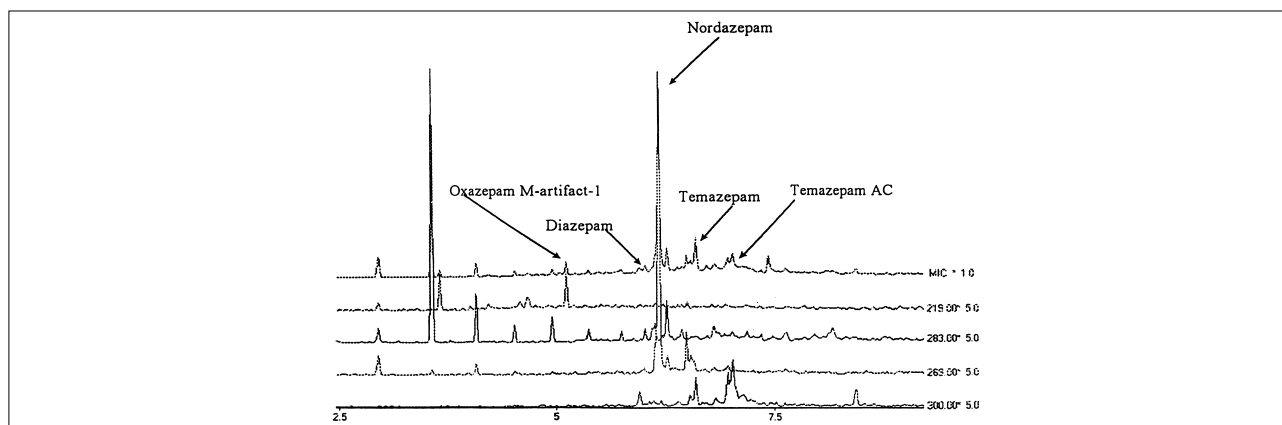

Fig. 4.9.4 Mass Chromatogram of analyzed drug in urine using Fast-GC/MS

4.10 Analysis of Amphetamine and Methamphetamine - LC

•Explanation

Fig. 4.10.1 shows an analysis example of amphetamine and methamphetamine, one group of narcotics. Amine types usually have alkali characteristics, so sodium perchlorate is added to the mobile phase to suppress peak tailing that may occur.

•Analytical Conditions

Instrument : HPLC

Column : Shim-pack CLC-ODS(M)
(150mmL. × 4.6mm i.d.)

Mobile Phase : (A) 10mM Sodium Phosphate Buffer (pH2.6)
containing 100mM Sodium Perchlorate

(B) Acetonitrile

(A) : (B) = 4 : 1 (V/V)

Column temp. : Room temp.

Flow rate : 1.0mL/min

Detection : UV-VIS Detector 210nm

References

This analysis data was provided by Dr. Yamamoto at Department of Regal Medicine, Faculty of Medicine, Kyoto University.

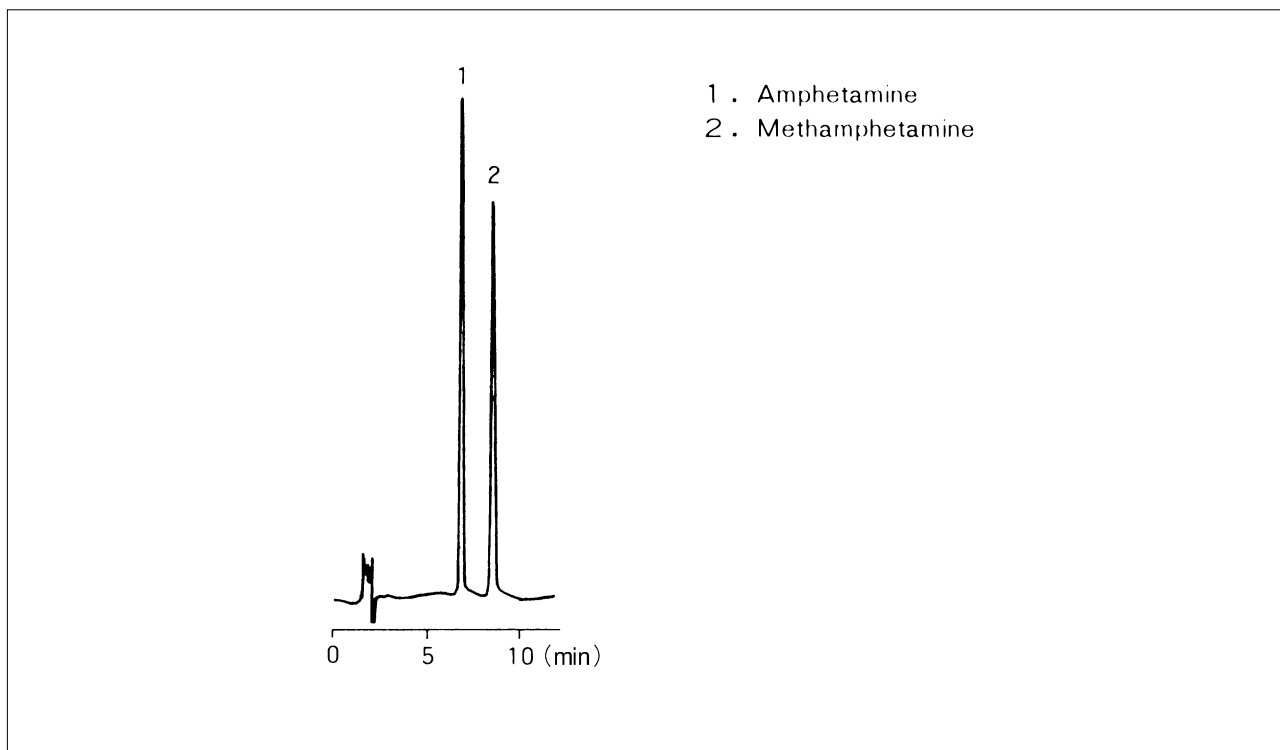

Fig. 4.10.1 Analysis of standard product



5. Others

5.1 Application of Automatic Diffuse Reflectance Attachment for Confirmation Test (1) - FTIR

•Explanation

The measuring methods for solid samples in the 13th revision of the Japanese Pharmacopoeia show that other than the KBr tablet method there is the ATR method and the diffuse reflectance method. The diffuse reflectance method - as a measuring method for powder samples - has become well known together with the spread of the Fourier transform infrared spectrophotometer (FTIR). This method requires minimal pretreatment time because there is no need for tablet production, so recently it is being used as a confirmation test method.

If multiple samples are to be measured for the confirmation test, measurement efficiency can be increased through the use of an automatic diffuse reflectance attachment. This data introduces the operation procedure for application of the automatic diffuse reflectance attachment in confirmation testing.

•Instrument

The automatic diffuse reflectance attachment shown in Fig. 5.1.1 can measure up to 24 samples at one time including background. The BASIC program is used to control the turntable.

•Measuring Example

Fig. 5.1.2 and 5.1.3 show measuring examples with the automatic diffuse reflectance attachment. Fig. 5.1.2 shows overlays of results for consecutive measurements of three sample cups containing powdered lactose diluted in KBr at 2wt%. The overlays show that measurement was achieved with good reproducibility. Fig. 5.1.3 shows the result for each spectrum after Kubelka-Munk conversion (K-M conversion). The weak peaks tend to be emphasized with the diffuse reflectance spectrum, but the use of the K-M conversion means that results near those for the KBr tablet method (transmission method).

•Analytical Conditions

Resolution	: 2cm ⁻¹
Accumulation	: 50
Apodization	: Happ-Genzel
Detector	: DLATGS
Accessory	: DRS-8010ASC
Software	: BASIC program, Japanese Pharmacopoeia support program

•Application Example

Fig. 5.1.4 shows one example of the measuring procedure when making use of an automatic diffuse reflectance attachment in confirmation testing. The optional BASIC program controls the automatic diffuse reflectance attachment. Use this together with the confirmation test program introduced in (0.3) to enable not only automated measurement but also automated spectrum evaluation.



Fig. 5.1.1 External view of automatic diffuse reflectance attachment

5.1 Application of Automatic Diffuse Reflectance Attachment for Confirmation Test (2) - FTIR

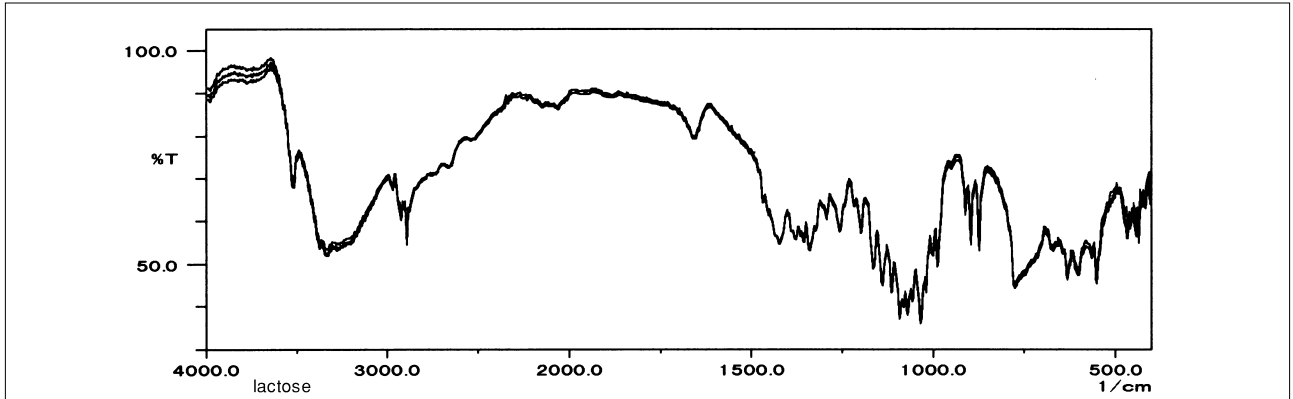

Fig. 5.1.2 Diffuse reflectance spectrum of lactose

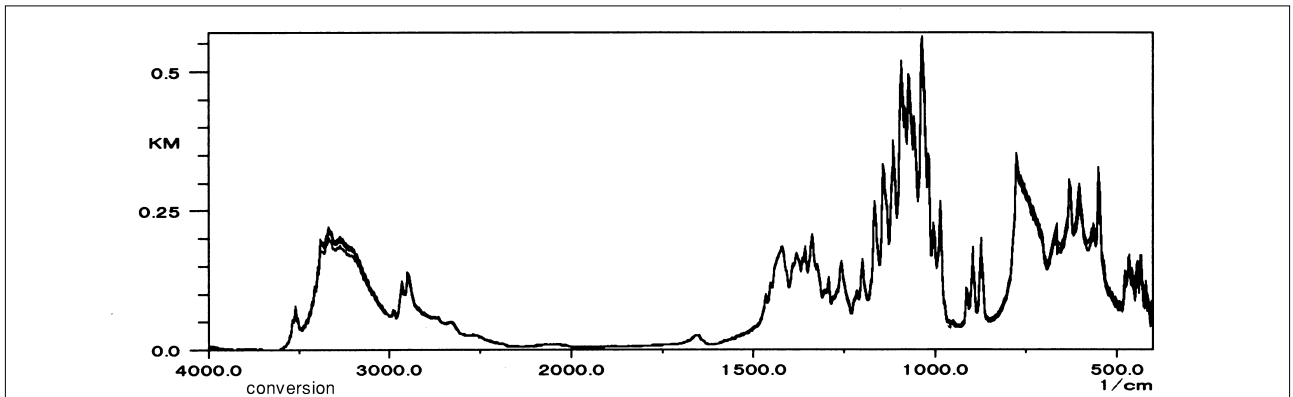

Fig. 5.1.3 Diffuse reflectance spectrum of lactose (after K-M conversion)

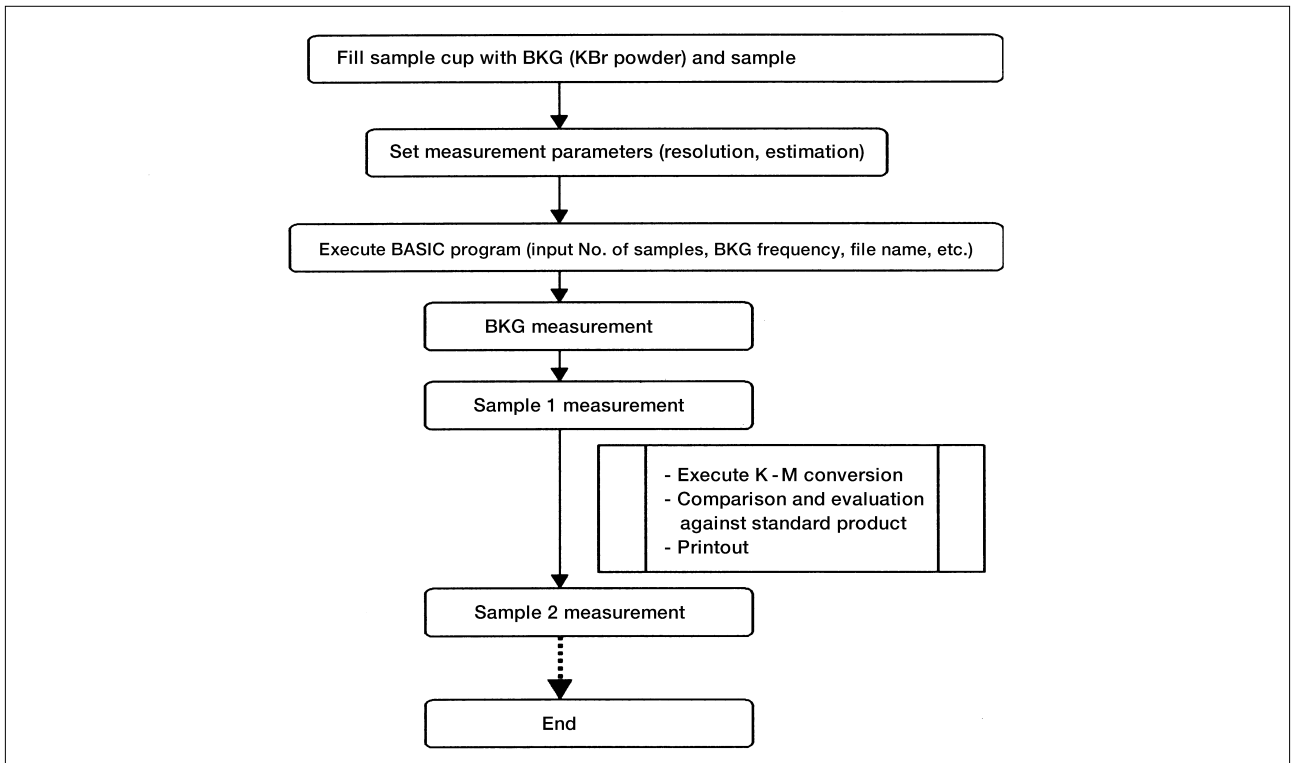

Fig. 5.1.4 Example of automatic diffuse reflectance measurement procedure

5.2 Confirmation Test Using Program Conforming to Japanese Pharmacopoeia (1) - FTIR

•Explanation

With the Japanese Pharmacopoeia, there are certain pharmaceuticals, in particular those that frequently used, that are regulated for determination of appropriateness of their characteristics and natures. Each type of test method is recorded in the pharmaceutical clauses, and the infrared spectrophotometry method also is used as a confirmation test method.

In addition to the standard software of the well-established Shimadzu FTIR systems there is a pharmaceutical analysis system available to enable easy output of confirmation analysis reports using the extremely convenient infrared spectrum method when the infrared spectrum is to be measured in accordance with the general test method of the Japanese Pharmacopoeia.

This data introduces the program that enables output of measurement results conforming to confirmation testing using the infrared spectrophotometry method of the general test method of the 13th revision of the Japanese Pharmacopoeia.

•Report Output Program for Confirmation Testing

In accordance with confirmation tests using infrared spectrophotometry, the spectrums of the sample and standard product are compared to clarify whether or not they conform. Clarification involves conformity of the absorption peak frequencies to within a permissible range and conformity of the intensity ratio of up to four specified absorption peaks. If all the values are within the permissible range, the sample is clarified as OK. If even one value exceeds the permissible range, the sample is clarified as NG.

The output results consist of the measurement parameters and calculation results, OK/NG decision result and standard and sample spectrums.

The calculation results in the upper section show the frequency and transmittance of the detected peaks for the sample and standard product. The column on the right shows the level of nonconformity for the detected frequencies. The lower section shows the intensity ratio of each evaluated peak. And markers denote the detected peaks and the peak selected for evaluation in the spectrums.

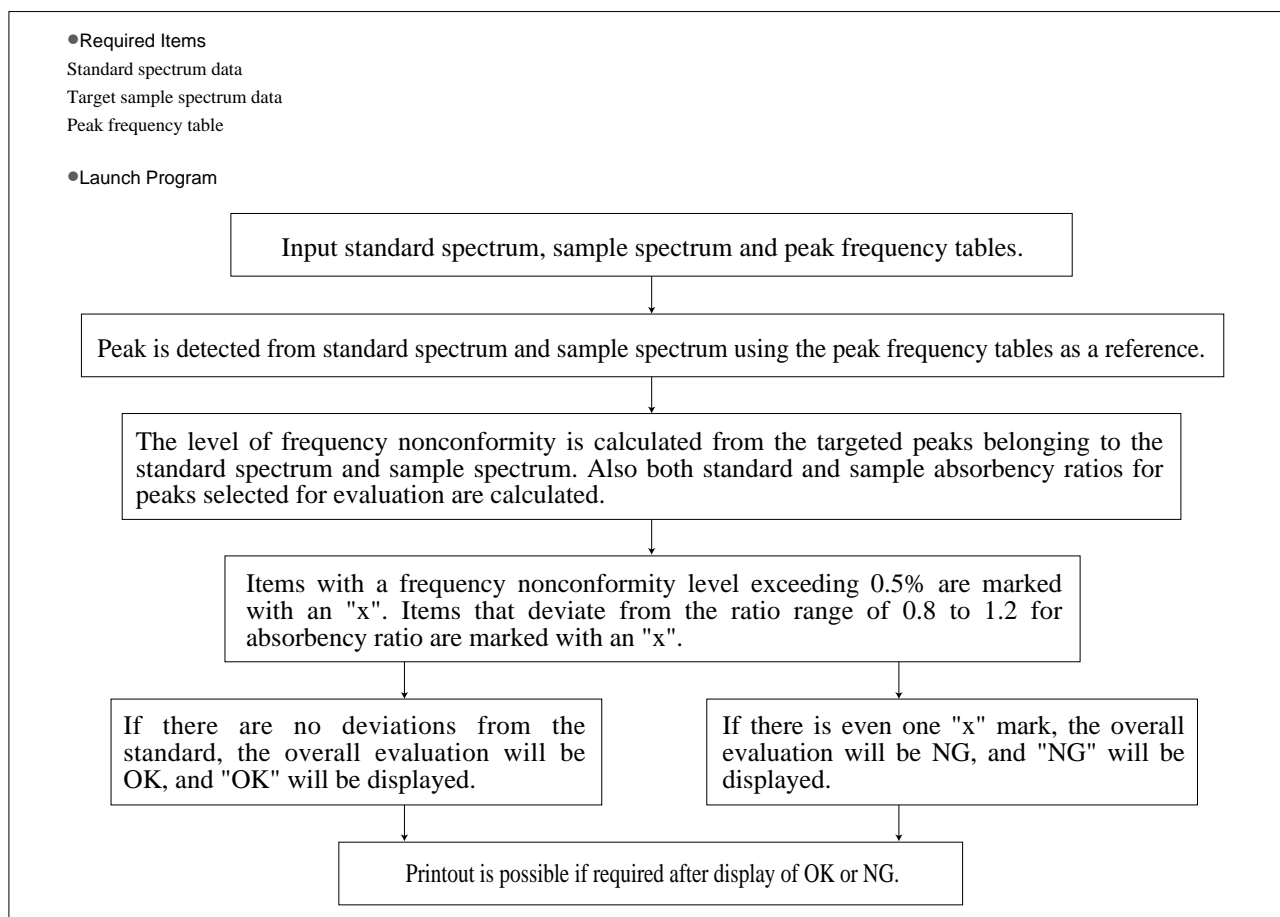

5.2 Confirmation Test Using Program Conforming to Japanese Pharmacopoeia (2) - FTIR

SAMPLE2. IRS :

Date : 2000/07/24

Data : HYPER IR

X-axis : 1/cm

Min Wave number : 400.20

Number of data : 3733

Gain : 1

Time : 18:47:20

User : SHIMADZU

Y-axis : %T

Max Wave number : 3999.12

Data interval : 0.96434

Aperture : auto

Integration : 50

Defector : standard

Apodize function : Happ

Wave number range : 1/cm

Resolution : 2.0

Mirror Speed : 2.8(low)

OK!

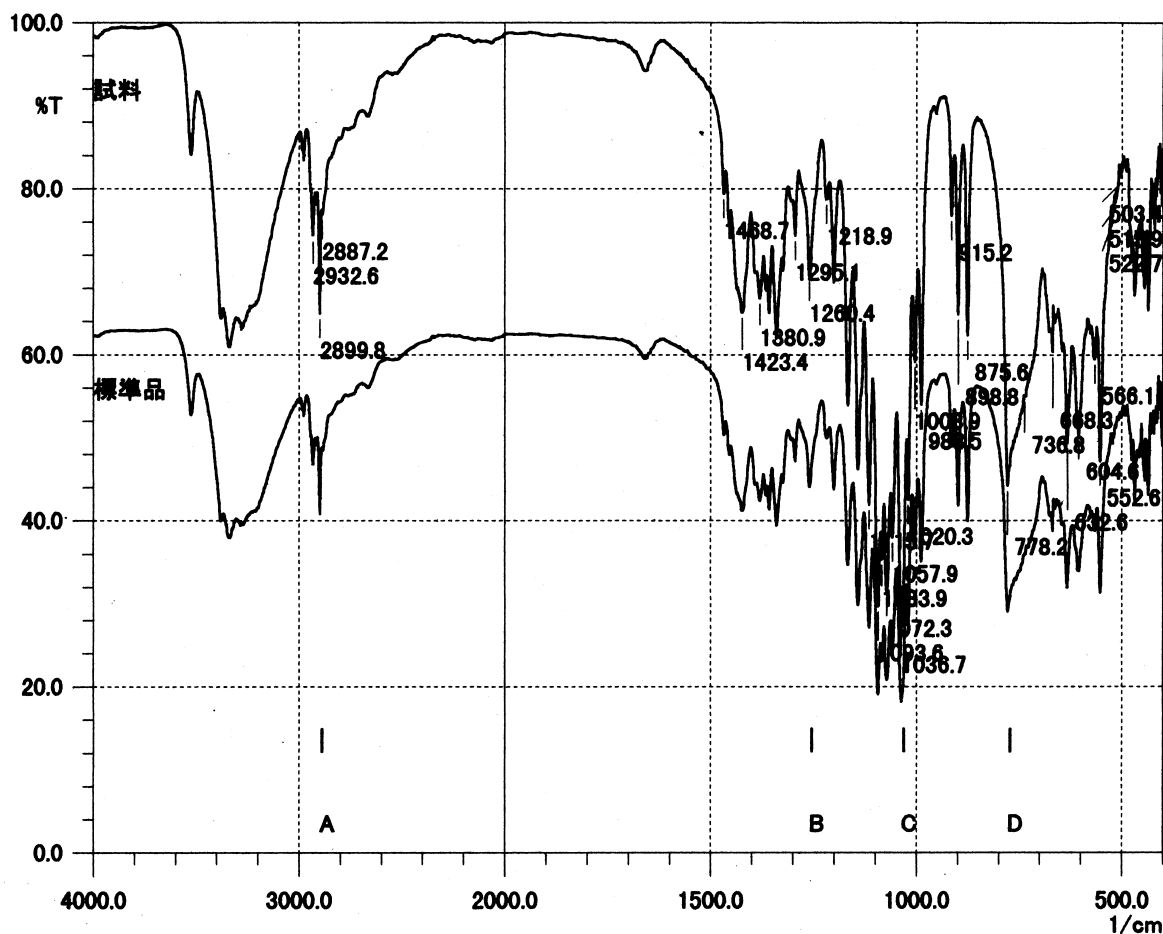

	Sample		Standard		Non conformity
A_P1	2899.8cm-1	65.0%T	2899.8cm-1	64.7%T	0.00%
_P2	1423.4cm-1	65.1%T	1423.4cm-1	65.3%T	0.00%
B_P3	1260.4cm-1	69.4%T	1260.4cm-1	69.8%T	0.00%
_P4	1093.6cm-1	29.7%T	1093.6cm-1	30.3%T	0.00%
C_P5	1036.7cm-1	27.0%T	1036.7cm-1	28.8%T	0.00%
_P6	988.5cm-1	54.0%T	988.5cm-1	55.6%T	0.00%
_P7	875.6cm-1	62.3%T	875.6cm-1	63.4%T	0.00%
D_P8	778.2cm-1	44.2%T	778.2cm-1	46.1%T	0.00%
_P9	632.6cm-1	49.4%T	633.6cm-1	50.6%T	0.15%
_P10	552.6cm-1	47.2%T	552.6cm-1	49.6%T	0.00%

A/B	1.1810	1.2142	0.9727
A/C	0.3297	0.3504	0.9411
A/D	0.5285	0.5636	0.9378
B/C	0.2792	0.2886	0.9675
B/D	0.4475	0.4641	0.9641
C/D	1.6028	1.6084	0.9965

5.4 Analysis of Lead (Pb) in Whole Blood - AA

•Explanation

From the point of view of labor hygiene, it is vital that the lead (Pb) in the whole blood of workers handling lead be measured. This data introduces an example of direct measurement of lead in whole blood.

•Lower limit of quantitation (guide)

Approximately 10ppb (in whole blood)

•Measuring Method

- (1) Dilute whole blood by five fold with a solution of orthophosphoric acid that has been diluted by 200 fold with water (original liquid is 85%) and leave the diluted whole blood to stand for one to two hours.
- (2) Mix the diluted whole blood with solution A shown in Chart 5.4.1 to the proportion shown in Chart 5.4.2 using an autosampler. And measure the mixture in accordance with the standard additive method for atomic absorption photometry (electro-thermal method).

•Analytical Conditions

Wavelength : 283.3nm
 Lamp Current : 10mA
 Slit Width : 0.5nm
 Lamp Mode : BGC-D₂

Furnace Program : (Tube: Platform type graphite tube)

STAGE	Temp.(°C)	Time(s)	Heat Mode	Flow Rate(L/min)
1	120	30	RAMP	0.10
2	250	10	RAMP	0.10
3	600	20	RAMP	0.10
4	600	10	STEP	0.10
5	600	3	STEP	0.00
6	2200	3	STEP	0.00
7	2500	2	STEP	1.00

10mL of orthophosphoric acid diluted by 200 fold
 1mL of 10g/L (nitric acid) palladium modifier
 10mL of triton X - 100
 10mL of (65%) nitric acid
 Add pure water to the above liquid to make a 1000mL solution

Chart 5.4.1 Preparation method for solution A

Final additive concentration (ppb)	Five-fold diluted whole blood (μL)	Solution A (μL)	Pb:500ppb standard solution (μL)	Total (μL)
0	150	150	0	300
10	150	144	6	300
25	150	135	15	300
50	150	120	30	300

Chart 5.4.2 Main conditions for measuring Pb in whole blood

Sample name	Measurement results (ppb)	Assurance value (ppb)
955a-1	59.0	50.1
955a-2	144	135.3
955a-3	319	306.3

Chart 5.4.3 Measurement result for Pb in whole blood

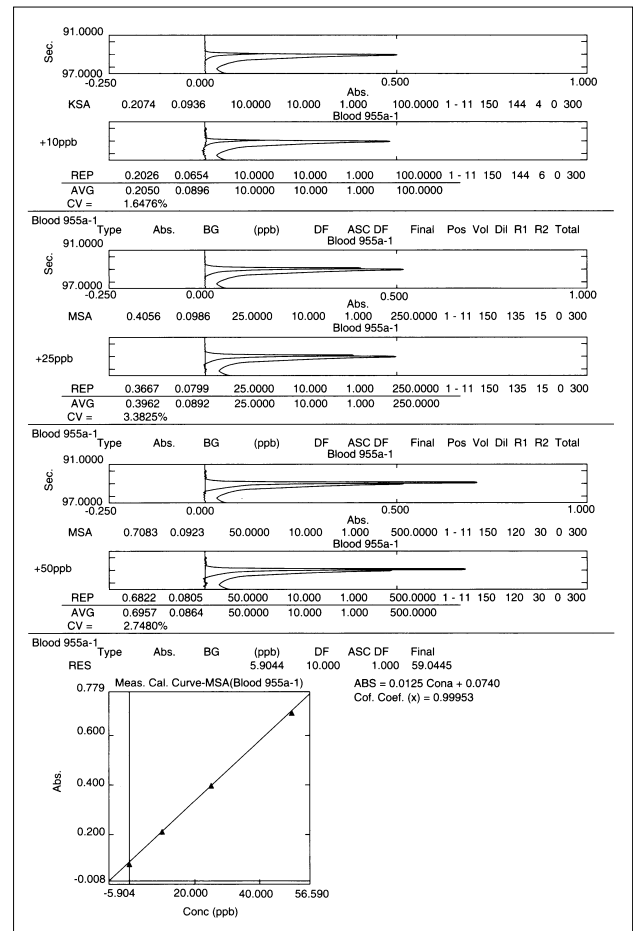

Fig. 5.4.1 Measurement example for Pb in whole blood



5.5 Quantification of Calcium (Ca) and Magnesium (Mg) in Energy Drink - AA

•Explanation

Gluconic acid calcium and L-aspartic acid magnesium that are elements in energy drinks can be measured easily and quickly by measuring Ca and Mg using the atomic absorption method (flame method).

•Lower limit of quantitation (guide)

Ca: 20µg/mL (when diluted by 100 fold)

Mg: 10µg/mL (when diluted by 100 fold)

•Measuring Method

(1)Place 1mL of sample in a 100mL measuring flask.

(2)Add strontium chloride to the above liquid and a standard solution to make solutions with 1000ppm Sr concentrations. The standard solution concentration can be alternatively mixed from 1 to 6µg/mL of Ca and Mg. Note, however, that sensitivity drops in Mg measurement, so the burner will have to be set at an angle for measurement.

•Ca Analytical Conditions

Wavelength : 422.7nm

Lamp Current : 10mA

Slit Width : 1.0nm

Lamp Mode : BGC-D₂

Flame : Air-C₂H₂

C₂H₂ Flow Rate : 2.0 L/min.

•Mg Analytical Conditions

Wavelength : 285.2nm

Lamp Current : 8mA

Slit Width : 0.5nm

Lamp Mode : BGC-D₂

Flame : Air-C₂H₂

C₂H₂ Flow Rate : 1.8 L/min.

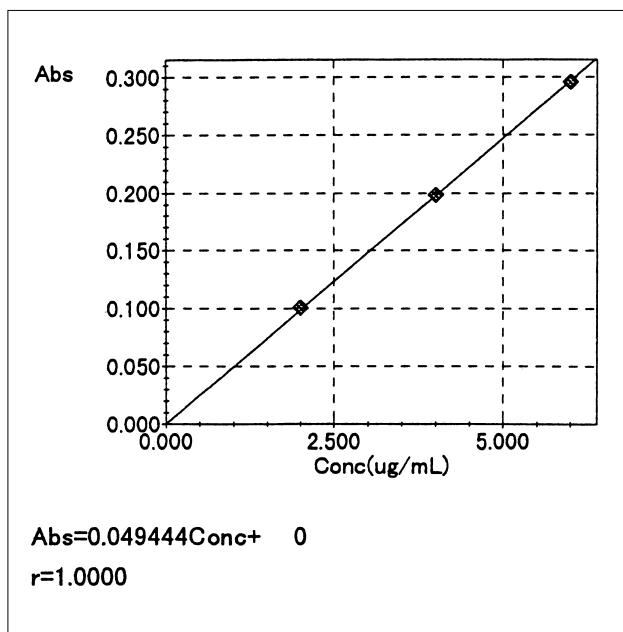

Fig. 5.5.1 Ca calibration curve

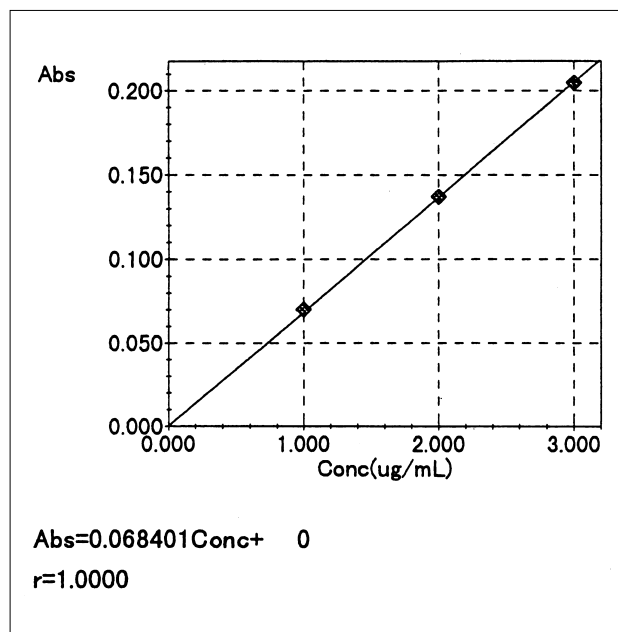

Fig. 5.5.2 Mg calibration curve

Chart 5.5.1 Measurement results

	Ca concentration in solution	Mg concentration in solution
Sample	351µg / mL	173µg / mL

5.6 Quantification of Vitamin B₁₂ (Cyanocobalamin) - AA

•Explanation

Cobalt is configured in vitamin B₁₂. Therefore vitamin B₁₂ can be indirectly quantified through the quantification of Co using atomic absorption photometry (electro-thermal atomization method).

•Lower limit of quantitation (guide)

Approximately 2.0µg/100mL (as vitamin B₁₂)

Approximately 1.0ppb (as Co)

•Measuring Method

(1)Set atomic absorption to the measurement conditions for Co.

(2)Create a calibration curve using a standard vitamin B₁₂ solution (40 to 80µg/100mL in this case), and analyze unknown sample.

•Analytical Conditions

Wavelength : 240.7nm

Lamp Current : 12mA

Slit Width : 0.2nm

Lamp Mode : BGC-D₂

Furnace Program :

(Tube: Pyro-graphite tube)

STAGE	Temp.(°C)	Time(s)	Heat Mode	Flow Rate(L/min)
1	120	30	RAMP	0.10
2	250	10	RAMP	0.10
3	600	20	RAMP	0.10
4	600	10	STEP	0.10
5	600	3	STEP	0.00
6	2500	3	STEP	0.00
7	2600	2	STEP	1.00

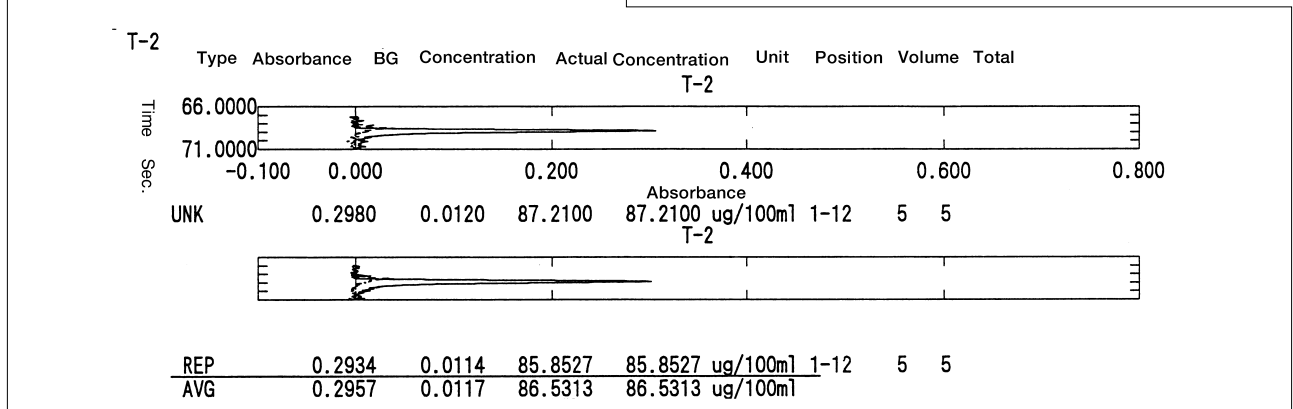
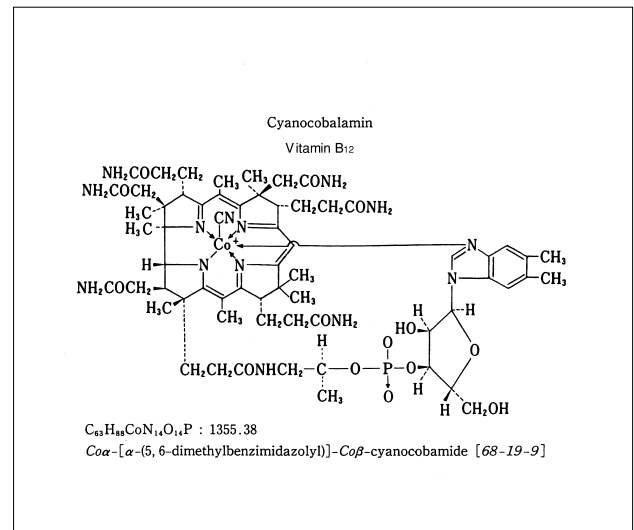
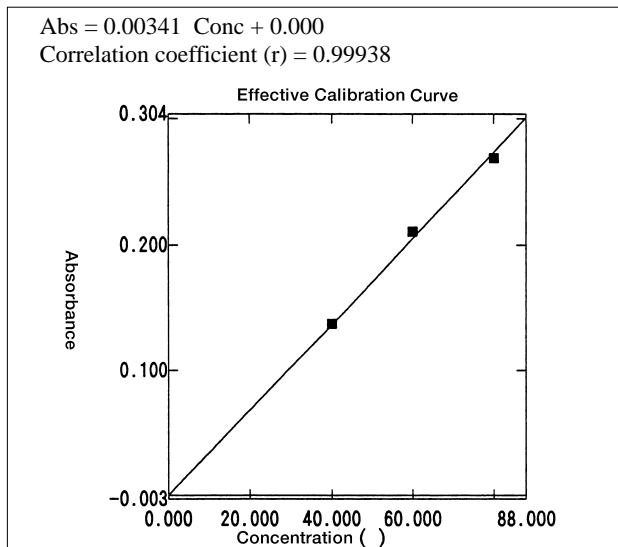

Fig. 5.6.1 Measurement example



5.7 Measurement of Enzyme Activity Using Shimadzu Spectrophotometer UV-3101PC - UV

•Explanation

Enzymes, being protein polymer groups that act as catalysts in chemical reactions, have matrix specificities and are used in many fields. There are many quantitative methods for enzymes starting with HPLC, though in general, chromatograph measuring involves quantifying as a substance. However, considering the role of enzymes, the measuring of the activity value should be more important. This data introduces a measuring example for glutamic oxaloacetic transaminase (GOT).

GOT, existing in nearly all mammal organs, particularly much of them in cardiac muscles, is used in the diagnosis of hepatitis and myocardial infarction. The principle of the measurement is shown in Fig. 5.7.1. NADH is measured as it reduces with the reaction, and the GOT activity value is determined from the rate of reduction.

The sample, in accordance with the Karmen procedure, contains MDH, LDH, NADH, L-aspartic acid and α -ketoglutaric acid. The factor for calculating out the

activity value from the absorbency reduction rate was obtained from the reaction shown in Fig. 5.7.2. Here, 500 μ mol/L pyruvic acid is used, and the factor corresponds to the amount of absorbency change in one minute when the change rate is 500 IU/L. Fig. 5.7.3 shows the measurement result. The absorbency difference was 0.076, so the factor becomes 6579.

•Analytical Conditions

Wavelength	: 340 nm
Slit Width	: 2.0 nm
React. Time	: 900.0 sec
Cycle Time	: 0.50 sec

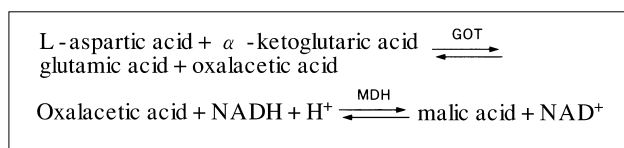

Fig. 5.7.1 Measurement principle (1)

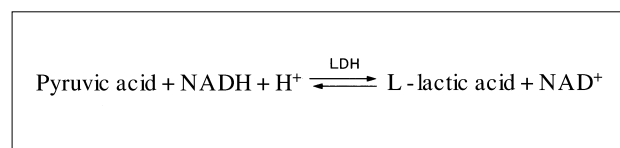

Fig. 5.7.2 Measurement principle (2)

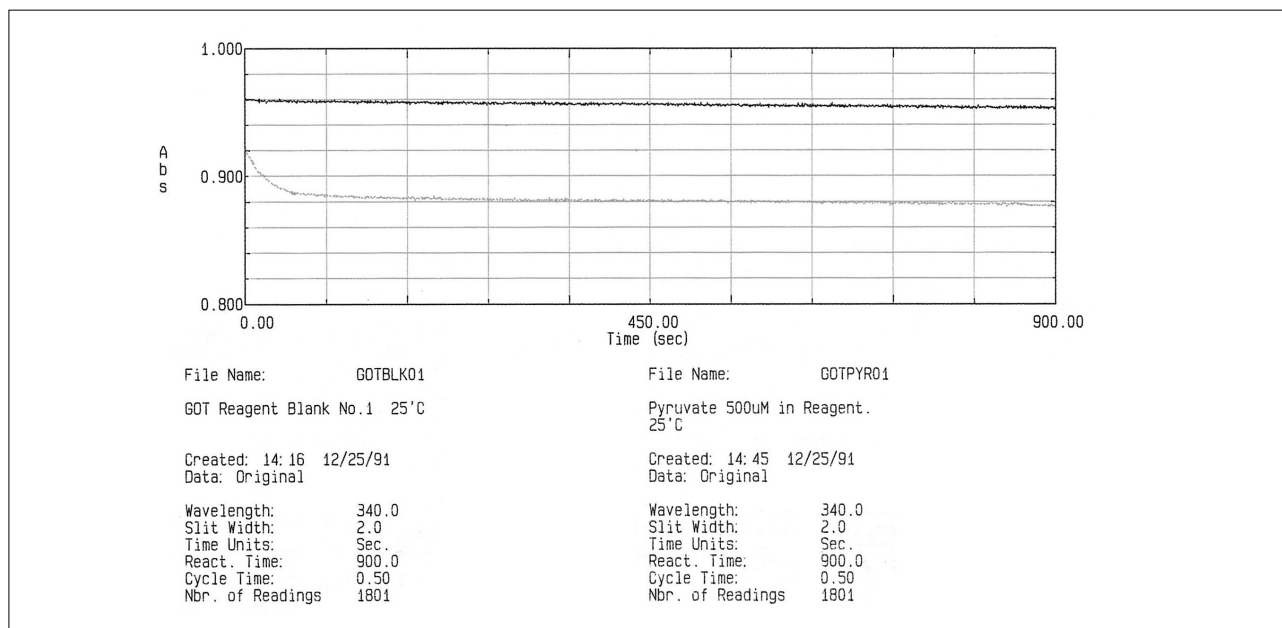

Fig. 5.7.3 Measurement results

5.8 Introduction of Shimadzu Automatic Dissolution Test System ADM that Achieves High Efficiency in Dissolution Tests for Pharmaceuticals (1)- UV

•Explanation

Efforts are being made to comprehensively approve later-developed pharmaceuticals as part of government policy to curb drug prices in the market for pharmaceuticals such as tablets. At the same time the Ministry of Health and Welfare have published a notification related to the implementation of biological equivalency tests for later-developed pharmaceuticals. When an application is made in connection with a later-developed pharmaceutical, assurance that the later-developed pharmaceutical is the equivalent of the forerunner pharmaceutical must be provided, and dissolution tests are now obligatory. These dissolution tests include many manual operations in the test process, which has placed considerable difficulty and burden on pharmaceutical manufacturers up to now. Here, Shimadzu would like to introduce the fully automated dissolution test system ADM developed to alleviate the problems above. This system performs dissolution tests in a continuous cycle for a maximum of 12 tablets with the eluant injection, tablet loading,

measuring, eluant discharge and vessel cleaning all being performed automatically.

Up to six of these devices can be connected in a row and the solving percent of each vessel can be simultaneously measured. Fig. 5.8.1 shows an example for an individual system and Fig. 5.8.2 shows the connection diagram. Chart 5.8.1 shows the measurement results for the prednisone tablet, which is one of the calibrators used by the United States Pharmacopoeia. And Fig. 5.8.3 shows the averaged dissolution percent curve for the six tablets.

•Analytical Conditions

Media Volume : 900 mL
 Rotation Speed : 50 /min
 Sampling Interval : 5, 10, 15, 20, 25, 30 min.
 Number of Washes : 1

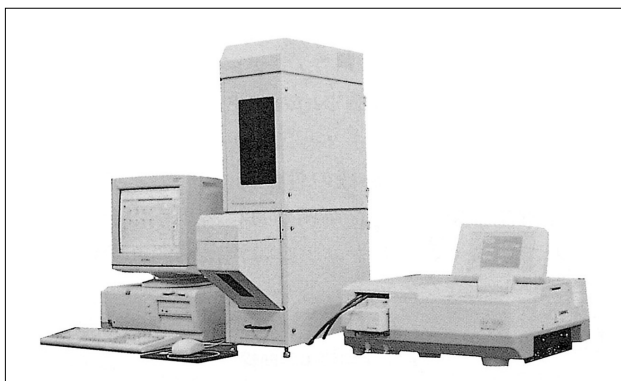

Fig. 5.8.1 Automatic dissolution test system

	10 min	20 min	30 min	Dissolution ratio	Pass/Fail
①	0.667Abs.	0.932	1.095	→ 44.1%	○
②	0.699	0.952	1.114	→ 45.0%	○
③	0.679	0.922	1.078	→ 43.5%	○
④	0.716	0.960	1.115	→ 45.0%	○
⑤	0.712	0.947	1.103	→ 44.5%	○
⑥	0.721	0.962	1.120	→ 45.2%	○
				Average dissolution percentage	: 44.6%
				CV value	: 1.47%

Note: Values for 5 min, 15 min and 25 min have been omitted.

Chart 5.8.1 Prednisone measurement results

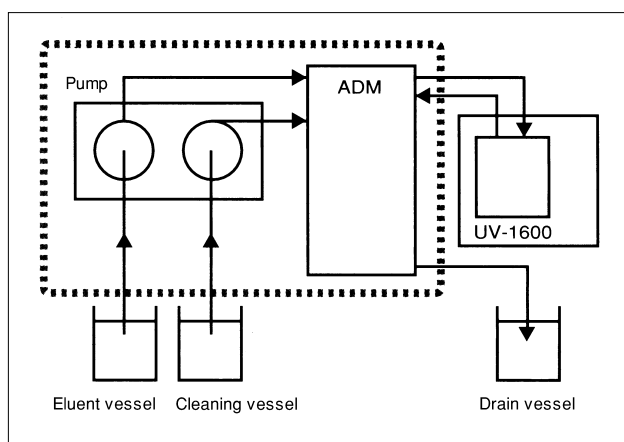

Fig. 5.8.2 Connection diagram

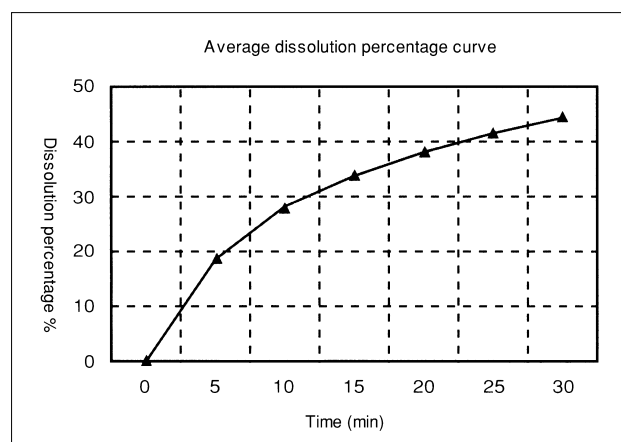

Fig. 5.8.3 Prednisone dissolution percentage curve

5.8 Introduction of Shimadzu Automatic Dissolution Test System ADM that Achieves High Efficiency in Dissolution Tests for Pharmaceuticals (2)- UV

•Explanation

Pharmaceutical manufacturers make great use of dissolution tests in the formulation and quality control of drugs, mainly for tablet medicines. The totally automated dissolution test system ADM fully automatically injects eluant, loads tablet, measures, discharges eluant and washes vessel. And it is vital that this "washing" be checked to confirm thorough implementation. This data introduces a study on this washing efficiency.

In order to comprehend the washing efficiency, No. 1 and No. 8 sample holders were filled with just distilled water and measured, while sample holders No. 2 through to No. 7 were loaded with prednisone tablets and measured. Chart 5.8.2 shows the measurement results and Fig. 5.8.4 shows those results in graph form. Washing efficiency is sufficient if the absorbency of No. 8 is close to zero, and a glance at Chart 5.8.2 shows that the absorbency value of No. 8 is in fact close to zero, which means that washing is close to being flawless.

Moreover, this device is equipped with a feature that enables "direct" measuring of the temperature in vessels.

Conventional dissolution test devices indirectly conjecture the liquid temperature in vessels by measuring the liquid temperature of the constant temperature bath holding the vessels; whereas, this device directly measures the liquid temperature by inserting a thermometer into the vessel during sampling, which enables greater accuracy in measurement. The measured temperatures are automatically saved as test history on the Audit Trail screen shown in Fig. 5.8.5 for future reference. Fig. 5.8.6 shows the software main screen.

•Analytical Conditions

- Media Volume : 900 mL
- Rotation Speed : 50 /min
- Sampling Interval : 5, 10, 15, 20, 25, 30 min.
- Number of Washes : 1

① Distilled water	0.000Abs.
② Prednisone 1	1.068
③ Prednisone 2	1.077
④ Prednisone 3	1.108
⑤ Prednisone 4	1.096
⑥ Prednisone 5	1.102
⑦ Prednisone 6	1.090
⑧ Distilled water	0.005

Chart 5.8.2 Measurement result

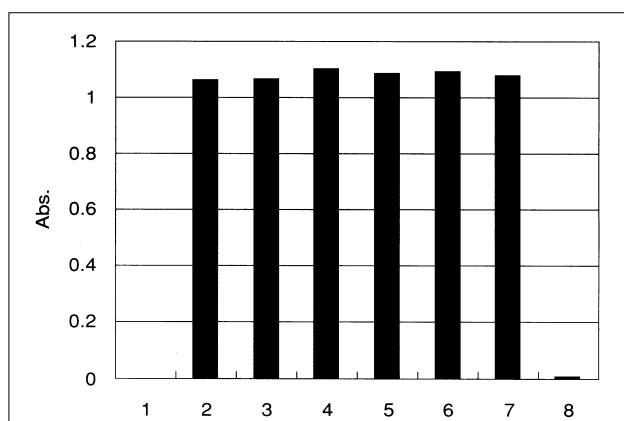

Fig. 5.8.4 Measurement result graph

Time	Command	Response Time	Status	Temperature Deg. C	Speed	Pic 1
03:38:06 pm	{U,244,244	N/A	OK			N/A
03:42:06 pm	{W,1,0,0}	N/A	OK	N/A	N/A	N/A
03:48:06 pm	{D,50,1,1,2	N/A	OK	36.9	50	N/A
03:53:36 pm	{S,900,0,0,	N/A	OK	36.9	50	N/A
03:56:36 pm	{U,244,244	N/A	OK			N/A
03:58:36 pm	{S,900,0,0,	N/A	OK	36.9	50	N/A
04:01:36 pm	{U,244,244	N/A	OK			N/A
04:03:36 pm	{S,900,0,0,	N/A	OK	36.9	50	N/A
04:06:36 pm	{U,244,244	N/A	OK			N/A
04:08:36 pm	{S,900,0,0,	N/A	OK	36.9	50	N/A
04:11:36 pm	{U,244,244	N/A	OK			N/A
04:13:36 pm	{S,900,0,0,	N/A	OK	36.9	50	N/A
04:16:36 pm	{U,244,244	N/A	OK			N/A
04:18:36 pm	{S,900,0,0,	N/A	OK	36.8	N/A	N/A
04:21:36 pm	{U,244,244	N/A	OK			N/A

Fig. 5.8.5 History record screen

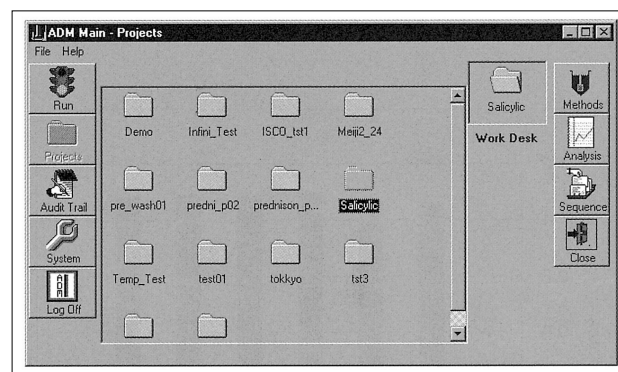

Fig. 5.8.6 Software main screen

5.9 Analysis of Histamine Using a Spectrofluorophotometer - RF

•Explanation

Histamine is one type of autacoid seen in various flora and fauna tissue and as a physiologically active amine it has many pharmacological activities for the likes of telangiectasia, smooth muscle contraction of bronchial tubes and intestines, etc., and gastric acid secretion stimulation. It is also known for its role in neurotransmitters, inflammation and wound treatment and cell multiplication.

In the case of food products, histamine tests are conducted in examinations for fish decay tests and substances that are the origin of allergic food poisoning. Measurement methods include thin-layer chromatography and high-performance liquid chromatography, but this data introduces a measurement example using fluorescence spectrophotometry incorporating the easy-to-operate fluorophotometer.

Generally o-phthalaldehyde, having alkalinity, reacts with primary amine to form a fluorescent substance. This reaction solution is acidified to remove most of the amine-caused fluorescence, except for histamine and some amino acid condensates. Also, the amino types other than histamine can be removed through washing the n-butanol eluate with a sodium chloride saturated sodium hydroxide solution. Fig. 5.9.1 shows the pretreatment method. And Fig. 5.9.2 and Fig. 5.9.3 show the calibration curve and fluorescent spectrum (60ng/mL).

•Pretreatment

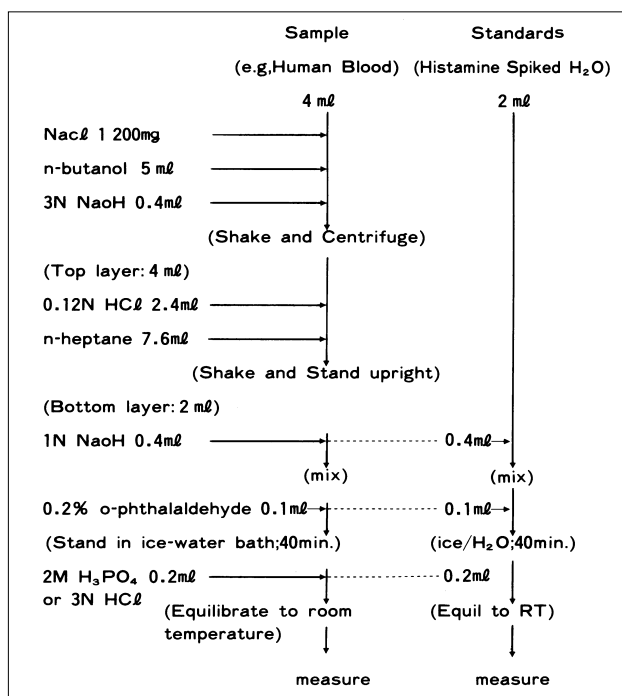

Fig. 5.9.1 Pretreatment

•Analytical Conditions

Scan Mode : Spect
 Select Mode : Em
 Slit Width : 5nm (Em,Ex)
 Scan Speed : Slow
 Response(sec) : Auto
 Sensitivity : High
 λRange : 350-600nm(Em)

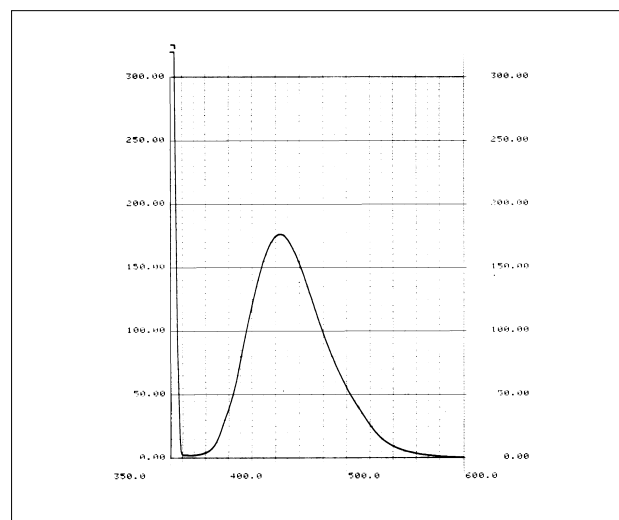

Fig. 5.9.2 Fluorescent spectrum of standard sample (60ng/mL)

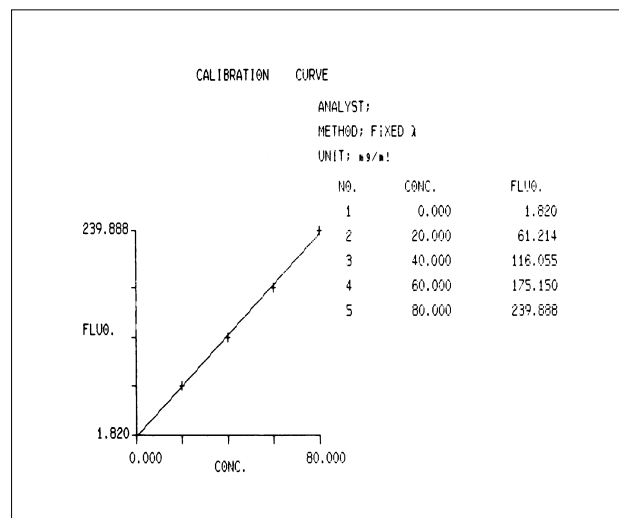

Fig. 5.9.3 Calibration curve



5.10 Purity Test and Confirmation Test Conforming to Japanese Pharmacopoeia - UV

•Explanation

There is a great accumulation of spectrophotometer history accompanying the measuring of elements in liquids using spectrophotometers, which are currently used in many fields as an established analysis method. This same method also is used for pharmaceuticals. And this data introduces the confirmation test and purity test using the absorbency ratio method from the methods laid down in the Japanese Pharmacopoeia.

Sodium Salicylate Purity Measurement with Absorbency Ratio Method

Dry sample, accurately weigh this out to $3.159g * f$ to $3.227g * f$, accurately add 20mL of 1N hydrochloric acid, accurately add 25mL of dioxane, allow time for dissolving, then add 1mL of thymol blue dioxane test agent, and top up with water to make a 50mL solution. This solution is used to conduct a purity test using the absorbency ratio method. Using water as a contrast, measure the absorbencies A1 and A2 at 435nm and 551nm wavelengths. The value for absorbency ratio r is determined from the equation $r = A2/(A1 + A2)$. The value for x is determined from the obtained r value and x - r curve.

Sodium salicylate weight: $3.2022g * f * x$

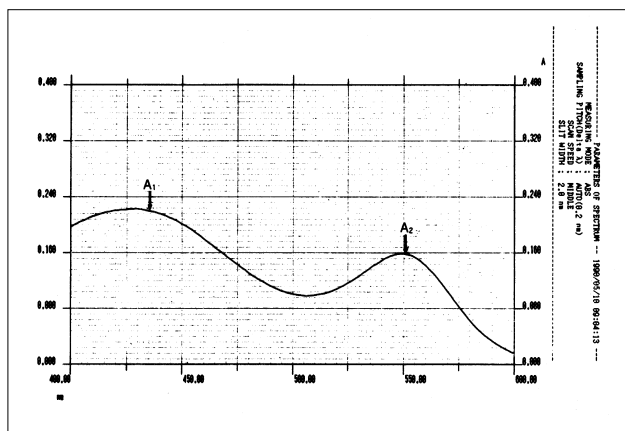

Fig. 5.10.1 Absorption spectrum for sodium salicylate

Measurement for Confirmation Test

1. Cyanocobalamin

The cyanocobalamin confirmation test involves confirming the existence of a local maximum of absorbency between 277 and 279nm, 360 and 364nm and 548 and 552nm wavelengths. Fig. 5.10.2 shows that these prerequisites are fulfilled.

2. Riboflavin

The local maximum of absorbency must exist between 265nm and 267nm (A1), 372nm and 374nm (A2), and 444nm and 446nm (A3) wavelengths. A1/A2 should be confirmed as 0.314 to 0.333 and A3/A1 as 0.364 to 0.388. Fig. 5.10.3 shows the absorption spectrum.

•Analytical Conditions

Measuring Mode : Absorbance

Slit Width : 2nm

Scan Speed : Middle

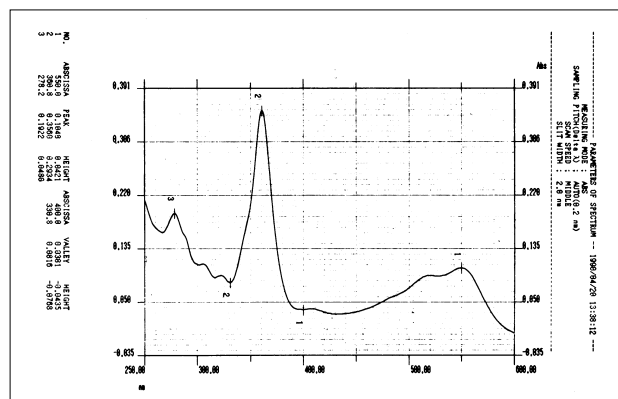

Fig. 5.10.2 Absorption spectrum for cyanocobalamin

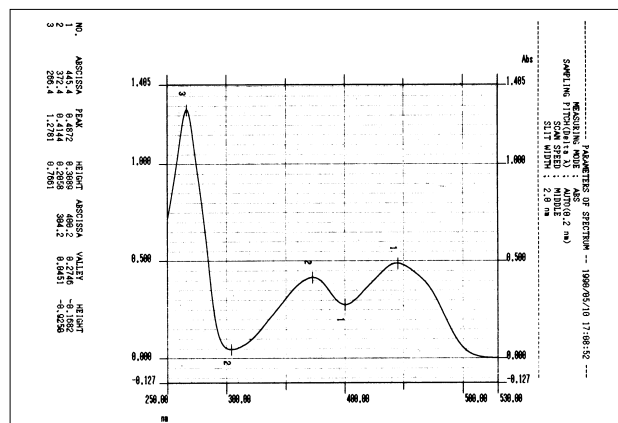

Fig. 5.10.3 Absorption spectrum for riboflavin

5.11 Measurement Examples Using Protein Analysis Program Pack - UV

•Explanation

For protein quantifying using spectrophotometers, the UV absorbency method employing 280nm absorbency peculiar to proteins and the coloring method that measures protein concentration with a calibration curve using a coloring reagent are well known. This data introduces the Lowry method and the Biuret method using a protein quantitation program pack that works for the four types of coloring method (Lowry, Biuret, BCA and CBB) and the UV absorption method.

Lowry Method

The Lowry method is a combination of the Biuret reaction, in which peptide linkage in protein reacts in alkalinity with Cu^{2+} to create a reddish purple complex, and the reaction in which proteins such as tyrosin, tryptophan and cystein react with phenol reagents to create a deep blue color. Absorbency is measured at 750nm for low-density protein and 500nm for rich protein, and quantified using the calibration curve method. Fig. 5.11.1 shows the measurement result for bovine blood serum albumine and Chart 5.11.1 shows the measurement conditions.

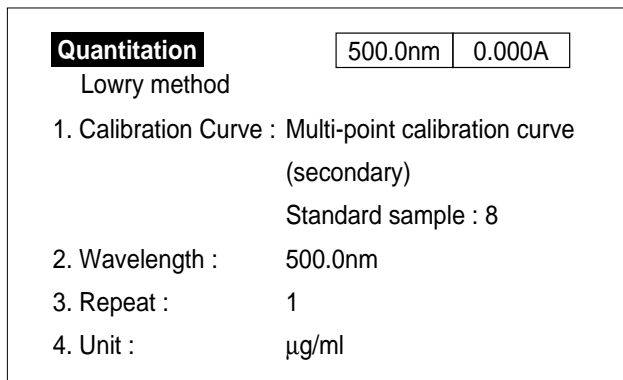

Chart 5.11.1 Measurement conditions

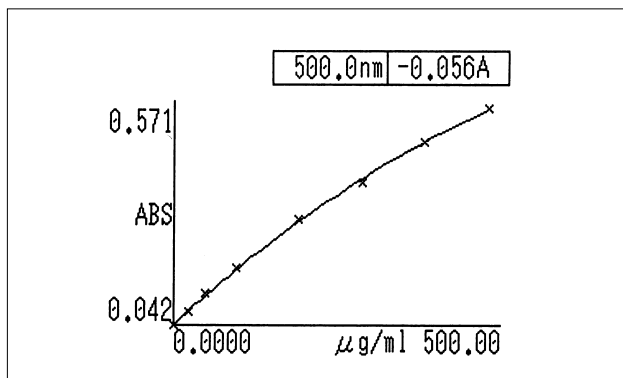

Fig. 5.11.1 Calibration curve for bovine blood serum albumine

•Analytical Conditions

Measuring Mode : Absorbance
Slit Width : 5nm
Scan Speed : Fast

Biuret Method

Protein reacts with Cu^{2+} in alkalinity to create a reddish purple color. This coloring occurs with the formation of the complex because the Cu^{2+} combines with the nitrogen atoms in the polypeptide chain that has lost its proton. This is called the Biuret reaction. In the Biuret method, absorbency is measured at 540nm wavelength of this color, and protein is quantified by the calibration curve. In comparison with the Lowry method, the level of coloring of the Biuret method is not very good, but the coloring percentage varies only slightly depending on protein types. Fig. 5.11.2 shows the measurement result for bovine blood serum albumine and Chart 5.11.2 shows the measurement conditions.

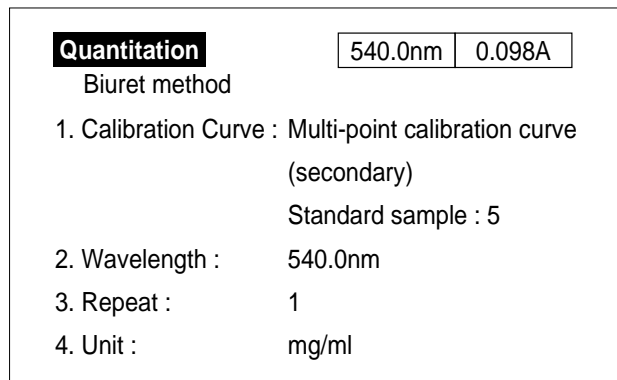

Chart 5.11.2 Measurement conditions

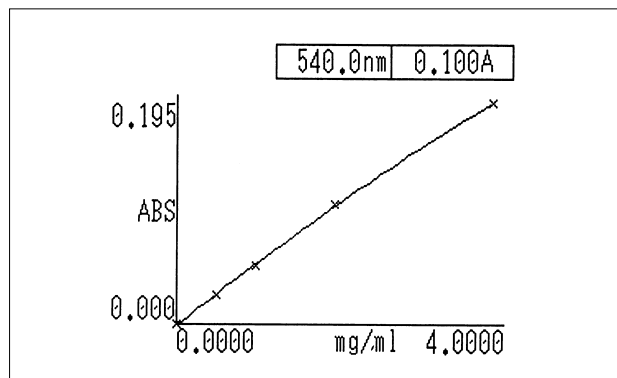

Fig. 5.11.2 Calibration curve for bovine blood serum albumine



5.12 Enzyme Reaction Measurement Using Kinetics Software - UV

•Explanation

Spectrophotometers are generally used with the aim of quantifying specified elements in samples when such samples are solutions. This data introduces a method where a specified wavelength absorbency change is measured along time sequence to quantify elements in the sample. Kinetics or Time Course measurement mode is used in this method.

Measurement of Creatine Kinase Activity Value in Blood Serum

Creatine kinase (CK) in blood serum makes ATP by phosphorescing its coexisting ADP in order to create creatine from creatine phosphoric acid. This ATP phosphoresces to form glucose due to the existence of hexo-kinase (HK). NAD is reduced into NADH to turn the created glucose-6-phosphate into 6-phosphogluconate. Therefore, the CK activity value can be determined by measuring the increased amount of NADH. Fig. 5.12.1 and Chart 5.12.1 show the measurement of absorbency changes at the 340nm wavelength, and the increase percent $\Delta A/\text{min}$ multiplied by the coefficient to determine the CK activity value.

Time Course Measurement of Coloring in L-Glutamic Acid

When L-glutamic acid is acidified using L-glutamic acid oxidase, hydrogen peroxide is formed. If this hydrogen peroxide is passed through a peroxidase blue pigment and measured using a spectrophotometer, the L-glutamic acid can be quantified. The time required to create the pigment and the stability of the created pigment must be checked in advance when quantifying samples that have been colored. Fig. 5.12.2 shows the absorbency change at 595nm during the 20 minutes after the coloring operation. Absorbency became stable after 5 minutes and held a stable value for 20 minutes. (The sample was provided by Yamasa Corporation.)

•Analytical Conditions

Measuring Mode : Absorbance
 Slit Width : 5nm
 Scan Speed : Fast

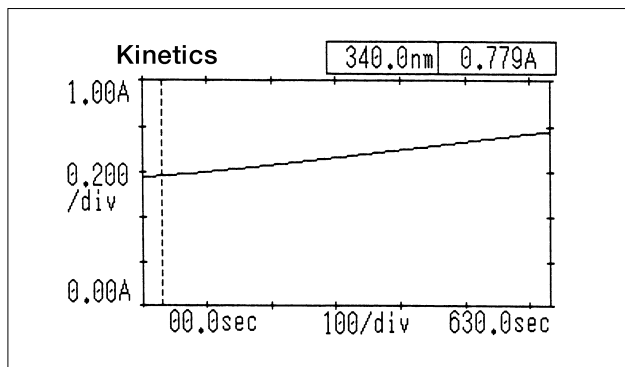

Fig. 5.12.1 Reaction curve for creatine kinase in blood serum

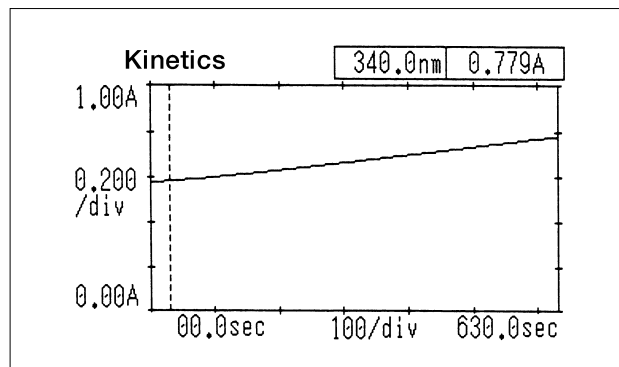

Fig. 5.12.2 Time sequence measurement after coloring for L-glutamic acid standard product

Kinetics			
		340.0nm	0.786A
Sample No	Initial Value(Abs)	$\Delta A/\text{min}$	Activity Value
1	0.4901	0.0079	39.322
2	0.5215	0.0115	57.402
3	0.5753	0.0201	100.11
4			(IU/ ℓ)

Chart 5.12.1 Activity value of creatine kinase in blood serum

5.13 Measurement of High-Speed Reaction Using a Stopped-Flow Device and MultiSpec-1500 - UV

•Explanation

All spectrums from 190nm to 800nm can be measured in 0.1 sec with the Shimadzu photodiode array spectrophotometer MultiSpec-1500 to enable observation of high-speed reaction. The data below introduces examples where reactions were sought using a combination of the MultiSpec-1500 with a stopped-flow attachment (solution mixing device).

A solution containing cytochrome c is mixed with an equal amount of ascorbic acid solution using the 2-solution mixing type stopped-flow attachment, and the reaction change was observed in time sequence.

Fig. 5.13.1 shows the obtained spectrum. The spectrum was measured at one-second intervals.

The 414nm peak is a characteristic peak of acidified cytochrome c. The intensity of this peak reduces and a reduction type peak appears at 410nm. In high-absorbency range, absorbency at 520nm and 550nm is increased. Inversely, absorbency decreases at 355nm. Fig. 5.13.2, Fig. 5.13.3 and Fig. 5.13.4 show extracted results of absorbency changes at each wavelength (520nm, 550nm and 355nm).

•Analytical Conditions

Measuring Mode : Absorbance

Wavelength Range : 300 ~ 600 nm

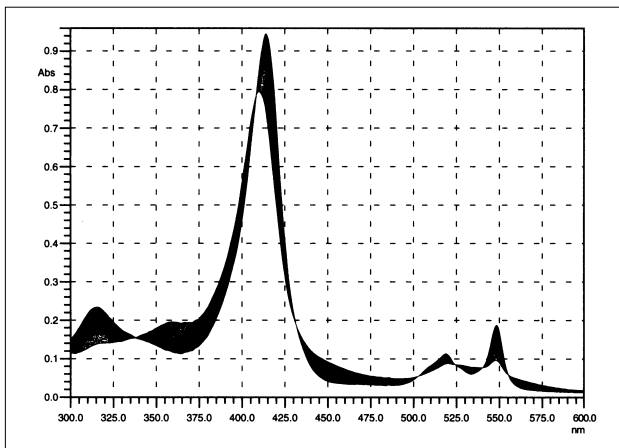

Fig. 5.13.1 Cytochrome c reduction by ascorbic acid

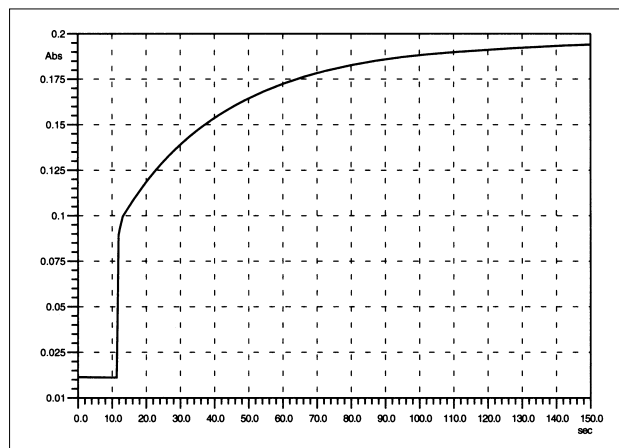

Fig. 5.13.3 Absorbency change at 550nm

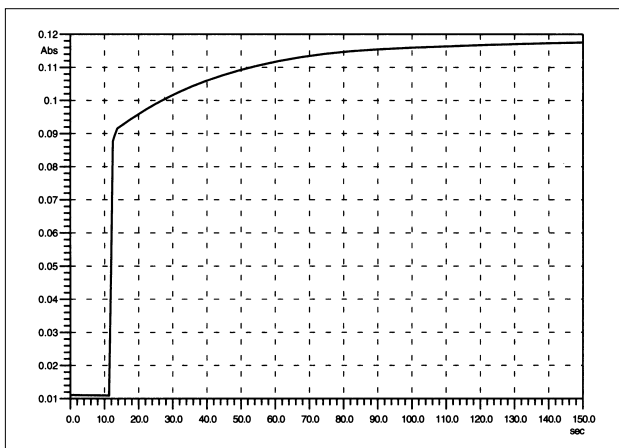

Fig. 5.13.2 Absorbency change at 520nm

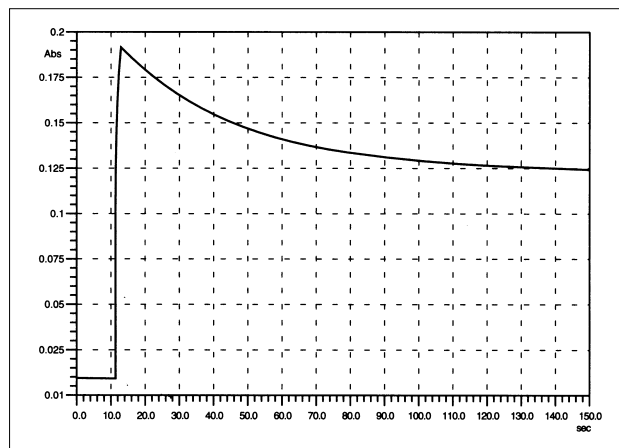

Fig. 5.13.4 Absorbency change at 355nm



5.14 Analysis of Pharmaceutical Residual Solvent (Observation of Separation) (1) - GC

•Explanation

At the International Conference on Harmonization of Pharmaceutical Requirements for Registration (ICH), the issue of unifying the pharmacopoeias of the participating countries was set as topic. In accordance with this, Japanese Ministry of Health and Welfare sent a notification dated the 30th of March 1998 carrying the guideline for pharmaceutical residue solvents to the hygiene authorities of each metropolis and district. A summary of the guideline contents is provided below. Also, Chart 5.14.1 shows the solvents specified in class 1 and class 2 together with their controlled values and the retention index (IX) for each solvent in capillary columns DB-624 and DB-WAX.

•Pretreatment

Mixture of class 1 and class 2 solvents with n-paraffin mixed in for retention index calculation was injected as sample.

•Analytical Conditions

Instrument	: GC-17AAFw
Column	: 1).DB-624 60m × 0.32mm i.d. df=1.8µm
	: 2).DB-WAX 30m × 0.32mm i.d. df=0.5µm
Col.Temp.	: 40°C – 4°C/min – 260°C
Inj.Temp.	: 280°C
Det.Temp.	: 280°C(w-FID)
Carrier Gas	: He 30cm/sec
Injection	: Split 1 : 50

References

See Shimadzu GC Datasheet No. 24 for details concerning separation results for each type of column for the 85 organic solvent elements including target elements for working environment measurement.

•Summary of Guideline

- (1)Residue solvent should be reduced to a level appropriate to product standard, GLP or other quality criteria or less.
- (2)Class 1 solvents that are known to cause non-permissible toxicity are not to be used without appropriate reasons.
- (3)The residue of class 2 solvents that show toxicity of a specified level or above, although not to the extent of class 1, should be controlled.
- (4)Ideally, class 3 solvents with minimal toxicity should be used.
- (5)In the case of class 1 and class 2 solvents, tests should be performed using the gas chromatography method, etc., that can individually detect solvents.
- (6)Only in the case of class 3 solvents, loss on drying method, which does not specify the type of solvent, can be used.

	Limit (ppm)	IX (DB-624)	IX (DB-WAX)		Limit (ppm)	IX (DB-624)	IX (DB-WAX)
Solvents of Class 1				2-Ethoxyethanol (Etelc)	160	756	1239
Benzene (Bz)	2	686	957	Ethylene glycol (EG)	310	797	1660
Tetrachloroethane (CCl4)	4	675	900	Formamide (FAM)	220	823	
1,2-Dichloroethane (12DCEa)	5	686	1088	Hexane (C6)	290	600	600
1,1-Dichloroethylene (11DCEy)	8	530	736	Methanol (MeOH)	3000	417	911
1,1,1-Trichloroethane (111TCEa)	1500	665	900	2-Methoxyethanol (Mecel)	50	682	1199
				Methylbutylketone (MBK)	50	831	1100
Solvents of Class 2				Methylcyclohexane (MecycC6)	1180	732	776
Acetonitrile (AcNt)	410	545	1026	N-methylpyrrolidone (N-MePrlDn)	4840	1144	1723
Chlorobenzene (ClBz)	360	884	1238	Nitromethane (NtMe)	50	629	1177
Chloroform (CRF)	60	652	1037	Pyridine (Pry)	200	786	1204
Cyclohexane (cycC6)	3880	670	729	Sulfolane (Sulfln)	160	1381	
Dichloromethane (DCM)	600	560	944	Tetralin (Tetrln)	100	1220	1565
1,2-Dimethoxyethane (12DMOEA)	100	679	935	Toluene (Tol)	890	794	1059
N,N-Dimethylformamide (DMF)	1090	861	1361	1,1,2-Trichloroethylene (TCEy)	80	720	1010
N,N-Dimethylacetamide (DMAc)	880	950	1437				
1,4-Dioxane (14-D)	380	738	1083	Xylene (EB,p-X,m-X,p-X)	2170	890,898 898,927	1146,1154 1160,1204

5.14 Analysis of Pharmaceutical Residual Solvent (Observation of Separation) (2) - GC

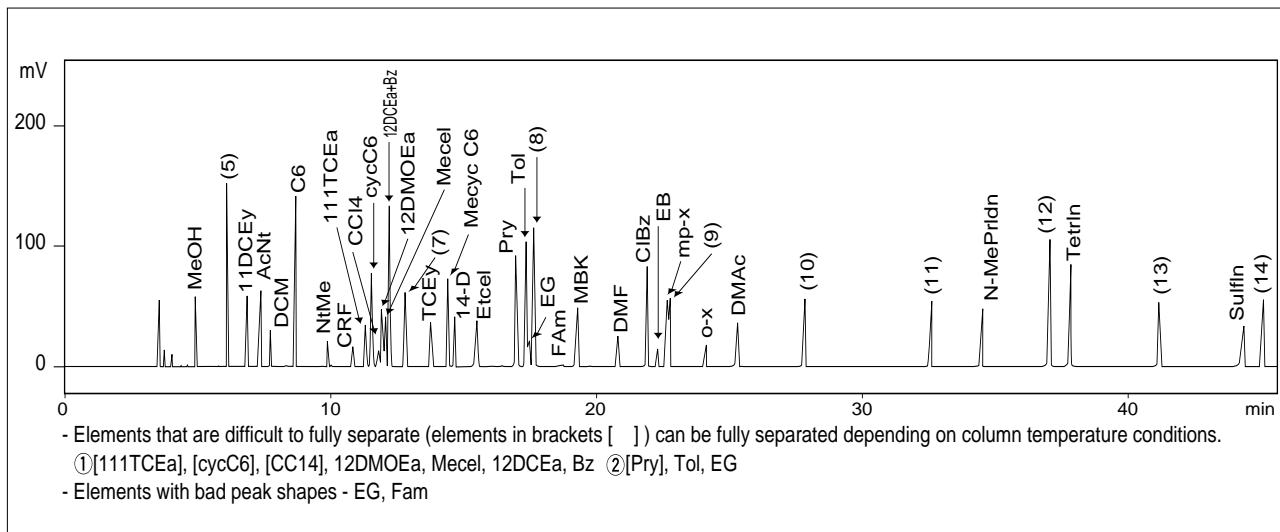

Fig. 5.14.1 Chromatograms of solvents using DB-624

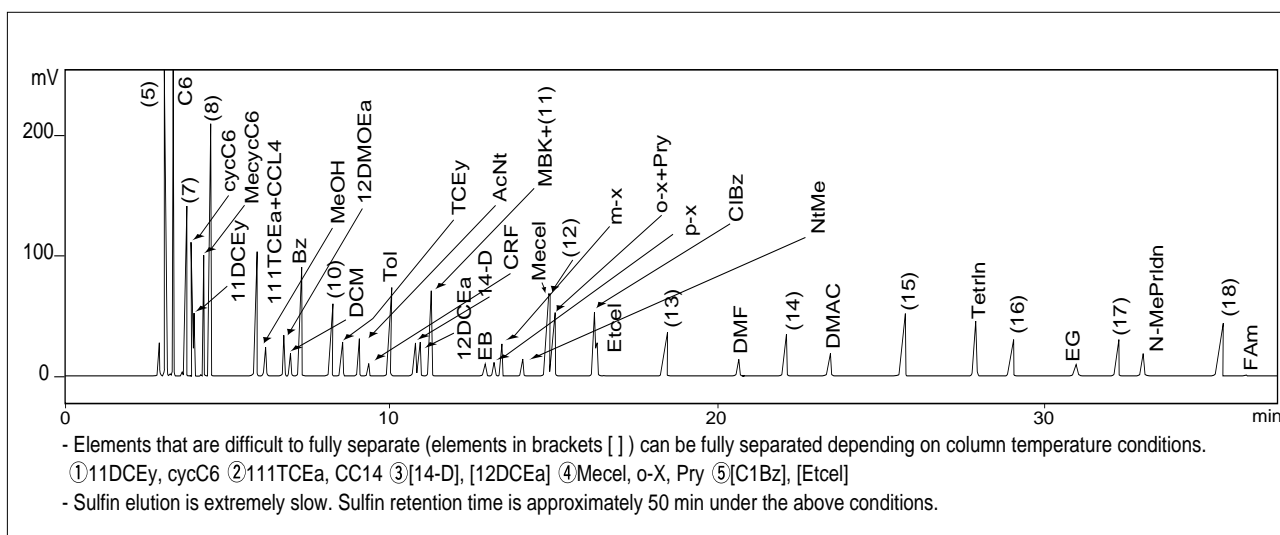

Fig. 5.14.2 Chromatograms of solvents using DB-WAX



5.15 Analysis of Pharmaceutical Residual Solvent According to <467> of United States Pharmacopoeia (USP) (1)- GC

•Explanation

In the United States Pharmacopoeia (USP), the pharmaceutical residue solvent analysis methods are laid down in <467> Organic volatile impurities, and four methods (I, IV, V and VI) are explained in the USP23 Third Supplement. Among these, Method IV is a form of analysis using a headspace method. This data introduces headspace gas chromatograms of lactose; a standard solution with water as solvent, and a test solution with controlled elements added at 1/20 concentration. A DB-624 wide-bore column was used for this analysis.

•Method IV Pretreatment Method

Standard solution:

Seal 5.0mL of water solution at the concentration shown in Fig. 5.15.1 together with 1g of sodium sulfuric anhydride in a vial.

Test solution:

Accurately measure out 100mg of the sample into a vial, add 5.0mL of water (or solvent recorded in clauses) and 1g of sodium sulfuric anhydride, and seal the vial.

After leaving the vial to stand for 60 min at a constant temperature of 80°C, analyze the headspace gas.

•Analytical Conditions

- Instrument : GC-17AAWFW + HSS-4A
- Column : DB-624 30m × 0.53mm i.d.
df=3.0µm
- Guard Column : silica column deactivated with phenylmethyl siloxane,
5m × 0.53mm i.d
- Col.Temp. : 40°C(20min) – 10°C/min – 240°C(20min)
- Inj.Temp. : 140°C
- Det.Temp. : 260°C (w-FID)
- Carrier Gas : He 35cm/sec
- Injection : Direct
- Sample Thermostatting : 80°C, 60min
- Headspace Injection Volume : 1mL

Organic Volatile Impurity	Limit(ppm)	Standard Conc.(µg/mL)
Benzene(Bz)	100	2
Chloroform(CRF)	50	1
1,4-Dioxane(14-D)	100	2
Methylene Chloride(DCM)	500	10
Trichloroethylene(TCEy)	100	2

Chart 5.15.1 USP controlled elements and controlled values together with standard solution concentrations

5.15 Analysis of Pharmaceutical Residual Solvent According to <467> of United States Pharmacopoeia (USP) (2)- GC

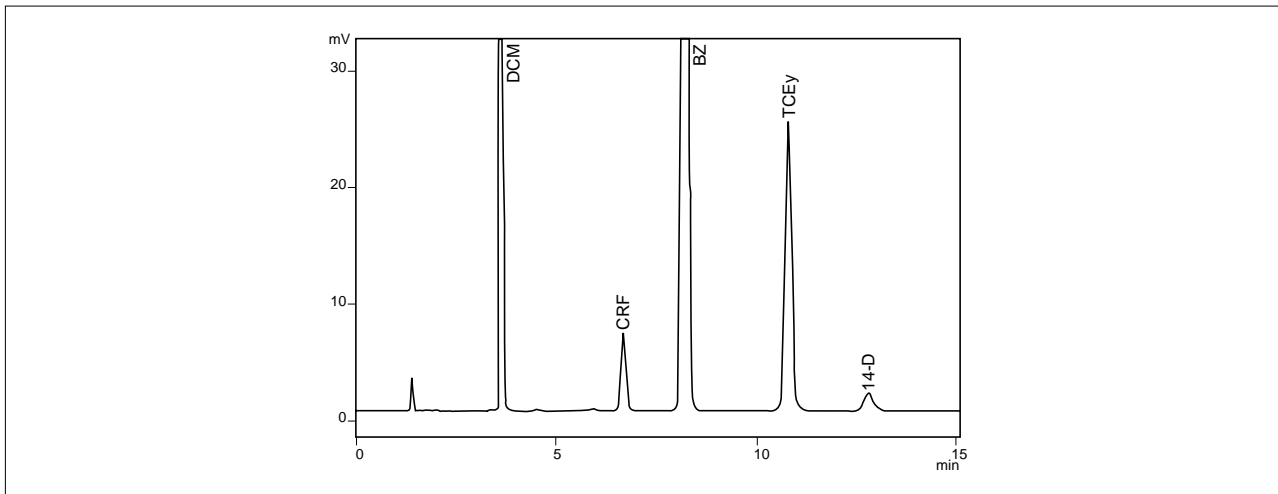

Fig. 5.15.1 Headspace gas chromatogram of standard solution

	DCM	CRF	Bz	TCEy	14-D
Separation rate (R)	16.6	6.4	9.4	5.8	
CV value (%)	1.42	1.08	1.51	1.72	3.34

Chart 5.15.2 Separation rate and CV value for each peak

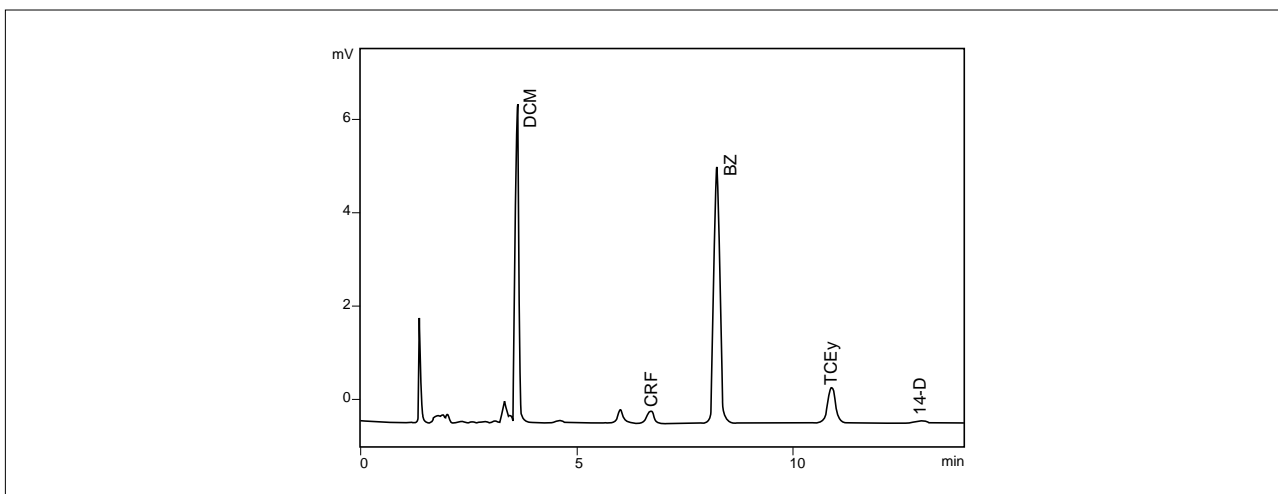

Fig. 5.15.2 Headspace gas chromatogram of lactose with 1/20 controlled elements added



5.15 Analysis of Pharmaceutical Residual Solvent According to <467> of United States Pharmacopoeia (USP) (3) - GC

•Explanation

Method V is an analysis method that involves direct introduction of the sample. The GC conditions are the same as Method IV.

•Method V Pretreatment Method

Accurately measure out the sample, dissolve it in water (or solvent recorded in clauses), and prepare approximately 20mg/mL of solution at the already known concentration. And analyze directly this solution.

•Analytical Conditions

Instrument	: GC-17A AWFw
Column	: DB-624 30m × 0.53mm i.d. : df=3.0µm
Guard Column	: silica column deactivated with phenylmethyl siloxane, 5m × 0.53mm i.d
Col.Temp.	: 40°C(20min) – 10°C/min – 240°C(20min)
Inj.Temp.	: 140°C
Det.Temp.	: 260°C(w-FID)
Carrier Gas	: He 35cm/sec
Injection	: Direct

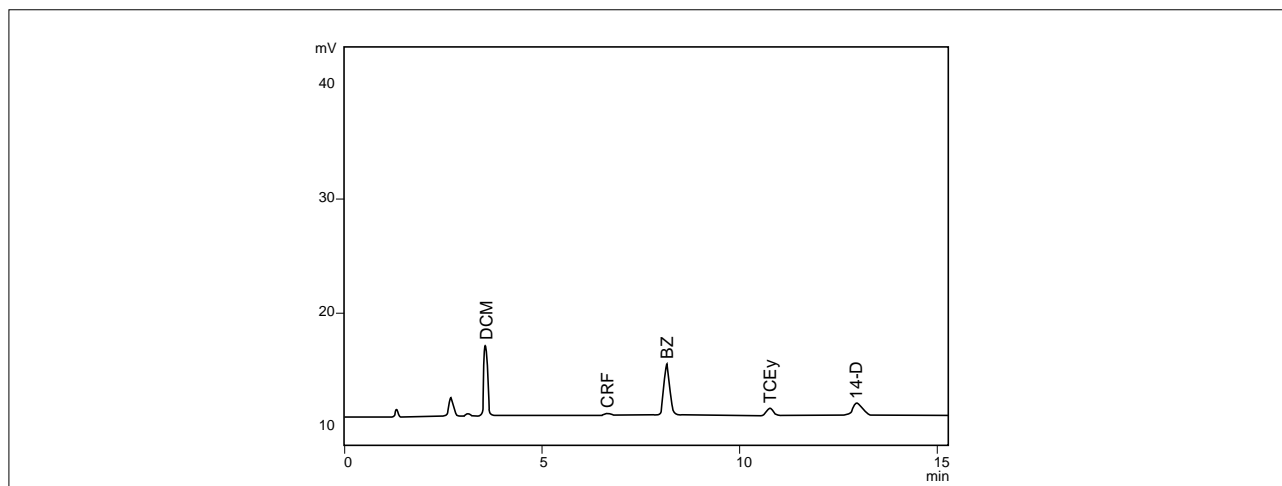

Fig. 5.15.3 Direct introduction gas chromatogram of standard solution (solvent: water)

<Reference>

USP GC Phases	Phase Composition	J&W Phase Recommendation
G1	Dimethylpolysiloxane oil	DB-1
G2	Dimethylpolysiloxane gum	DB-1
G3	50% Phenyl – 50% methylpolysiloxane	DB-17
G5	3-Cyanopropylpolysiloxane	DB-23
G6	Trifluoropropylmethylpolysiloxane	DB-210
G7	50% 3 – Cyanopropyl-50% phenylmethylsilicone	DB-225
G14	Polyethylene glycol (average molecular weight of 950 – 1,050)	DB-WAX
G15	Polyethylene glycol (average molecular weight of 3,000 – 3,700)	DB-WAX
G16	Polyethylene glycol (average molecular weight of 15,000)	DB-WAX
G17	75% Phenyl – 25% methylpolysiloxane	DB-17
G19	25% Phenyl – 25% Cyanopropylmethylsilicone	DB-225
G20	Polyethylene glycol (average molecular weight of 380 – 420)	DB-WAX
G25	Polyethylene glycol TPA (Carbowax 20M terephthalic acid)	DB-FFAP
G27	5% Phenyl – 95% methylpolysiloxane	DB-5,DB-5ms
G28	25% Phenyl – 75% methylpolysiloxane	DB-35,DB-35ms
G32	20% Phenylmethyl – 80% dimethylpolysiloxane	DB-35,DB-35ms
G35	Polyethylene glycol & diepoxide esterified with nitroterephthalic acid	DB-FFAP
G36	1% Vinyl – 5% phenylmethylpolysiloxane	DB-5,DB-5ms
G38	Phase G1 plus a tailing inhibitor	DB-1
G39	Polyethylene glycol (average molecular weight of 1,500)	DB-WAX
G41	Phenylmethyldimethylsilicone (10% phenyl substituted)	DB-5,DB-5ms
G42	35% Phenyl – 65% dimethylvinylsiloxane	DB-35,DB-35ms
G43	6% Cyanopropylphenyl – 94% dimethylpolysiloxane	DB-624,DB-1301

(From J&W Scientific 1996/97 GC Technical Reference)

5.16 Analysis of Pharmaceutical Residual Solvent (Standard Sample Analysis Using HS-GC) (1) - GC

•Explanation

This data introduces analysis examples using the headspace gas chromatograph method for solvents specified as class 1 and class 2 in the guideline for pharmaceutical residual solvents in a notification from the Ministry of Health and Welfare (March 30, 1998)

•Pretreatment

On the assumption that the sample for analysis (pharmaceutical) has been diluted 100 fold in water or another suitable solvent (for example: dissolve 0.20g of pharmaceutical in 20mL of water), water solutions of the controlled elements were prepared to 1/100 concentration. (Note that 1,1,1-trichloroethane has an extremely high controlled concentration in comparison with the other elements, so it was prepared at 1/10000 concentration of the controlled value.) These 5mL batches of these solutions were sealed in vials, stored for one hour at a constant 80°C, and the headspace gases analyzed.

•Analytical Conditions

Instrument	: GC-14BPFsc
Column	: DB-624 30m × 0.32mm i.d. : df=1.8μm
Col.Temp.	: 40°C(20min) – 10°C/min – 240°C
Inj.Temp.	: 140°C
Det.Temp.	: 260°C(FID,ECD)
Carrier Gas	: He 35cm/sec
Injection	: Split 1 : 5
Sample Thermostatting	: 80°C, 60min
Headspace Injection Volume	: 2mL(Option Syringe)

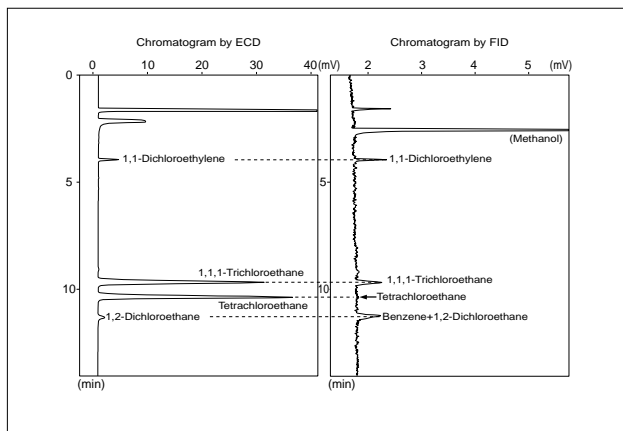

Fig. 5.16.1 Headspace gas chromatogram for class 1 solvents

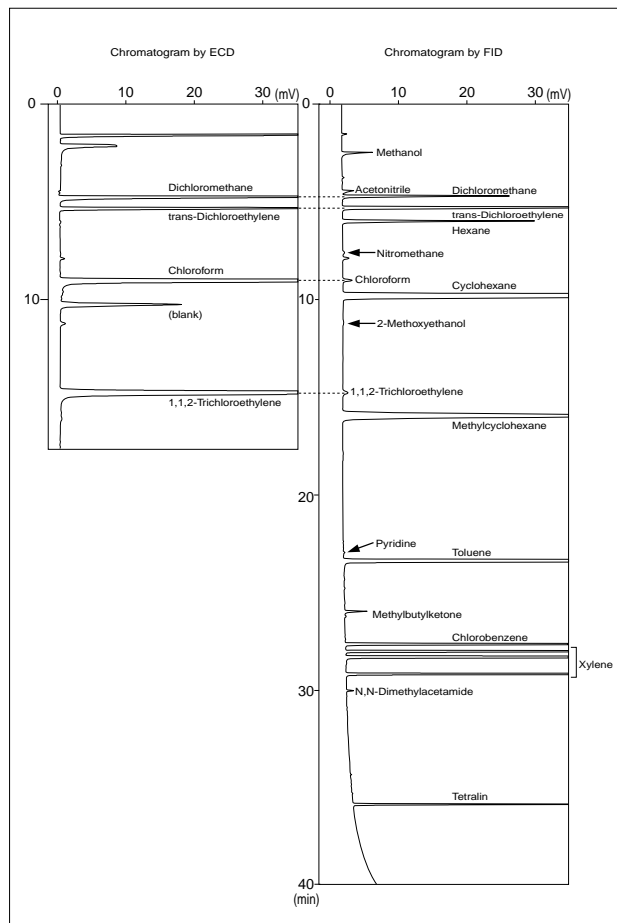

Fig. 5.16.2 Headspace gas chromatogram for class 2 solvents

5.16 Analysis of Pharmaceutical Residual Solvent (2) - GC

•Explanation

Residual analysis of organic solvents, etc., used in the production process of pharmaceuticals can be performed with the solvent extraction method. But this data introduces analysis examples using the headspace gas chromatograph method that enables easier analysis.

•Analytical Conditions

Instrument : GC-14BPFsc+HSS-2B
 Column : CBP20 25m × 0.33mm i.d.
 df=0.5μm
 Col.Temp. : 50°C(7min) – 10°C/min – 150°C
 Inj.Temp. : 250°C
 Det.Temp. : 250°C (FID)
 Carrier Gas : He 1.3mL/min
 Injection : Split 1 : 15
 Sample Quantity : 1g
 Sample Thermostatting : 150°C, 60min
 Headspace Injection Volume : 0.8mL

•Pretreatment

The samples for analysis (pharmaceuticals) were sealed in vials, stored at a specified constant temperature for a specified time and the headspace gas analyzed.

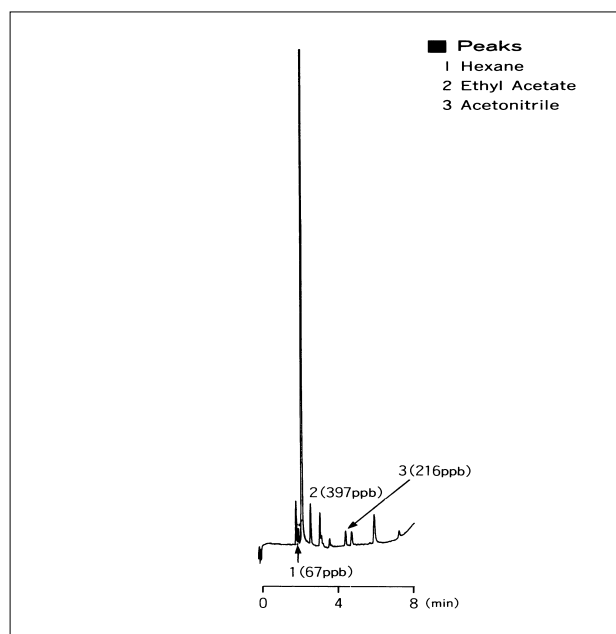

Fig. 5.16.1 Headspace gas chromatogram of pharmaceutical raw material (liquid sample)

•Analytical Conditions

Instrument : GC-14BPFsc+HSS-2B
 Column : CBP20 25m × 0.53mm i.d.
 df=1.0μm
 Col.Temp. : 40°C(8min) – 10°C/min – 180°C
 Inj.Temp. : 220°C
 Det.Temp. : 220°C (FID)
 Carrier Gas : He 5.3mL/min
 Injection : Split 1 : 3.4
 Sample Quantity : 0.25g
 Sample Thermostatting : 80°C, 40min
 Headspace Injection Volume : 0.8mL

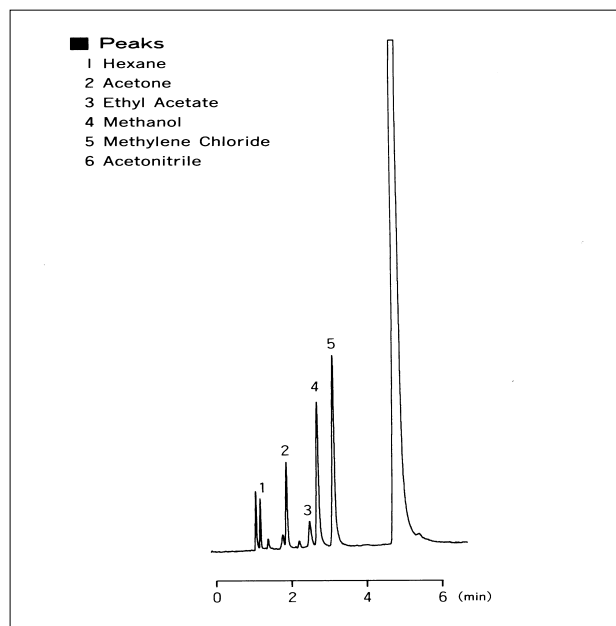

Fig. 5.16.2 Headspace gas chromatogram of pharmaceutical raw material (powder sample)

5.17 Analysis of Residual Solvent in a Powdered Medicine - GC

•Explanation

This data introduces analysis of two types of powdered medicine using the headspace gas chromatograph method.

•Analytical Conditions

Instrument : GC-14BPF_{sc}+HSS-2B
Column : CBP20 25m × 0.53mm i.d.
df=1.0μm
Col.Temp. : 60°C
Inj.Temp. : 220°C
Det.Temp. : 220°C (FID)
Carrier Gas : He 4.9mL/min
Injection : Split 1 : 4
Sample Quantity : 0.5g
Sample Thermostatting : 150°C, 30min
Headspace Injection Volume : 0.8mL

•Pretreatment

The samples for analysis (pharmaceuticals) were sealed in vials, stored at a specified constant temperature for a specified time and the headspace gas analyzed.

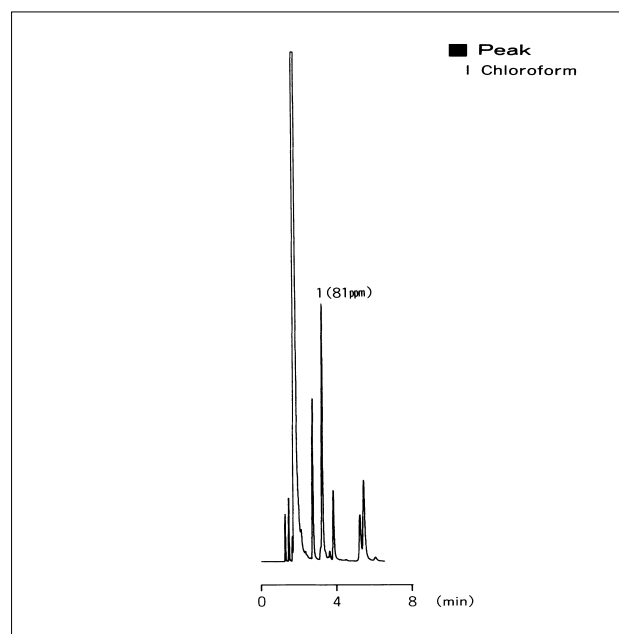

Fig. 5.17.1 Headspace gas chromatogram of powdered medicine A

•Analytical Conditions

Instrument : GC-14BPF_{sc}+HSS-2B
Column : CBP20 25m × 0.53mm i.d.
df=1.0μm
Col.Temp. : 50°C(5min) – 10°C/min – 180°C
Inj.Temp. : 220°C
Det.Temp. : 220°C (FID)
Carrier Gas : He 5.3mL/min
Injection : Split 1 : 4
Sample Quantity : 0.3g
Sample Thermostatting : 80°C, 40min
Headspace Injection Volume : 0.8mL

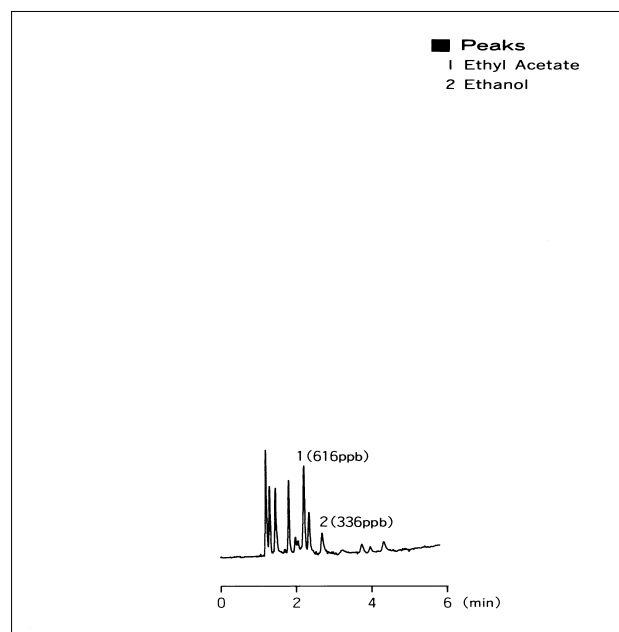

Fig. 5.17.2 Headspace gas chromatogram of powdered medicine B



5.18 Analysis of Residual Solvent in Pharmaceutical Bulk - GC

•Explanation

This data introduces analysis of residual solvents (MEK and toluene) in pharmaceutical bulk. To provide a sensitivity comparison, one sample was sealed in a vial by itself and another was saturated in water and sealed in a vial.

•Pretreatment

One sample (pharmaceutical bulk) was sealed in a vial by itself and another was saturated in water and sealed in a vial, and both were stored for one hour at a constant temperature of 150°C and the headspace gas analyzed.

•Analytical Conditions

Instrument	: GC-14BPF _{sc} +HSS-2B
Column	: ULBON HR-20M 25m × 0.32mm i.d. df=0.25µm
Col.Temp.	: 50°C(7min) – 10°C/min – 220°C
Inj.Temp.	: 230°C
Det.Temp.	: 230°C (FID)
Carrier Gas	: He 1.3mL/min
Injection	: Split 1 : 14
Sample Quantity	: 0.3g
Sample Thermostatting	: 150°C, 60min
Headspace Injection Volume	: 0.8mL

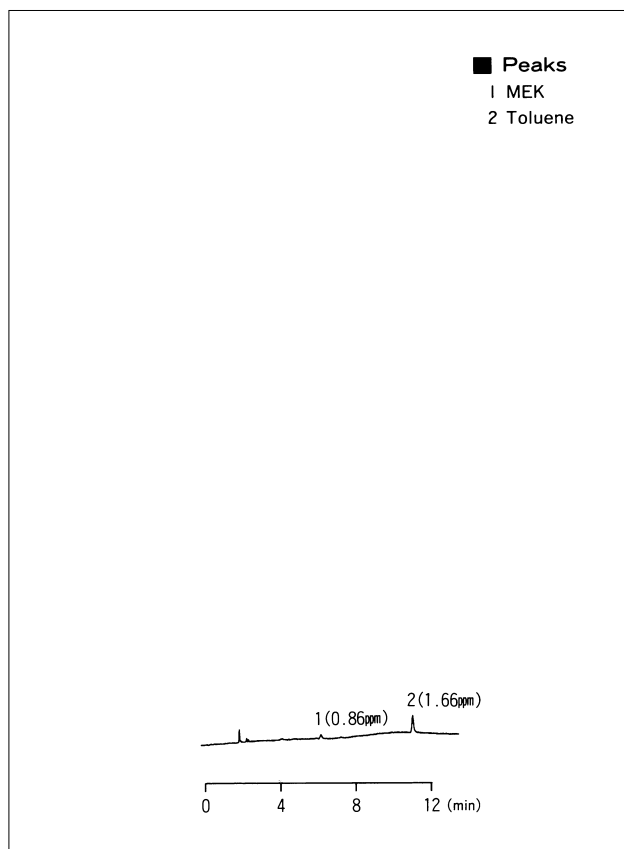

Fig. 5.18.1 Headspace gas chromatogram of pharmaceutical bulk

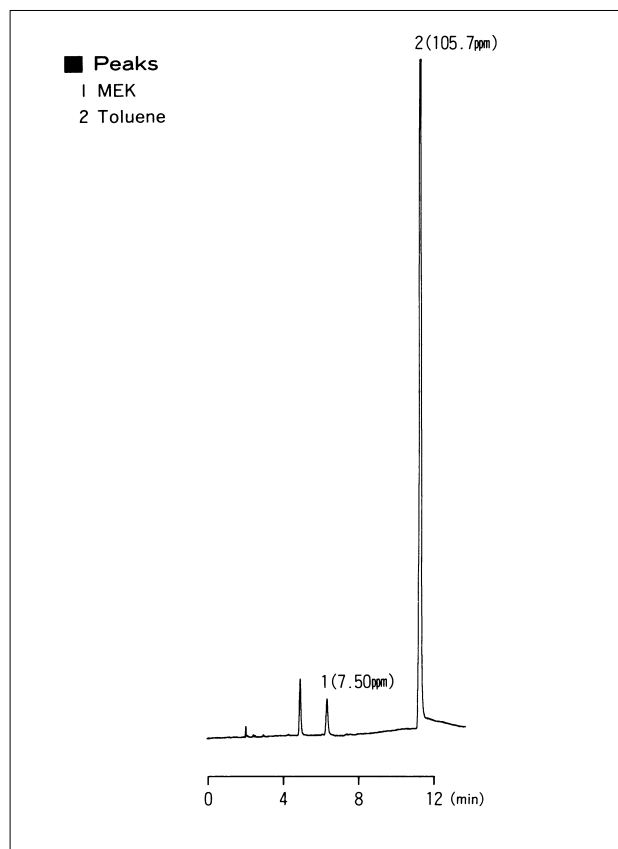

Fig. 5.18.2 Headspace gas chromatogram of pharmaceutical bulk with 300(L of water added)

5.19 Analysis of Ethylene Oxide in Antiseptic First Aid Adhesive Tape - GC

•Explanation

This data introduces analysis of residual ethylene oxide in antiseptic first aid adhesive tape using the headspace gas chromatograph method.

•Pretreatment

An adhesive tape was sealed in a vial by itself, stored for 30 min at a constant temperature of 100°C and the headspace gas analyzed.

•Analytical Conditions

Instrument	: GC-14BPFsc+HSS-2B
Column	: CBP20 25m × 0.33mm i.d. df=0.5µm
Col.Temp.	: 50°C
Inj.Temp.	: 200°C
Det.Temp.	: 200°C (FID)
Carrier Gas	: He 1.3mL/min
Injection	: Split 1 : 15
Sample Quantity	: 3 Sheets (1g)
Sample Thermostatting	: 100°C, 30min
Headspace Injection Volume	: 0.8mL

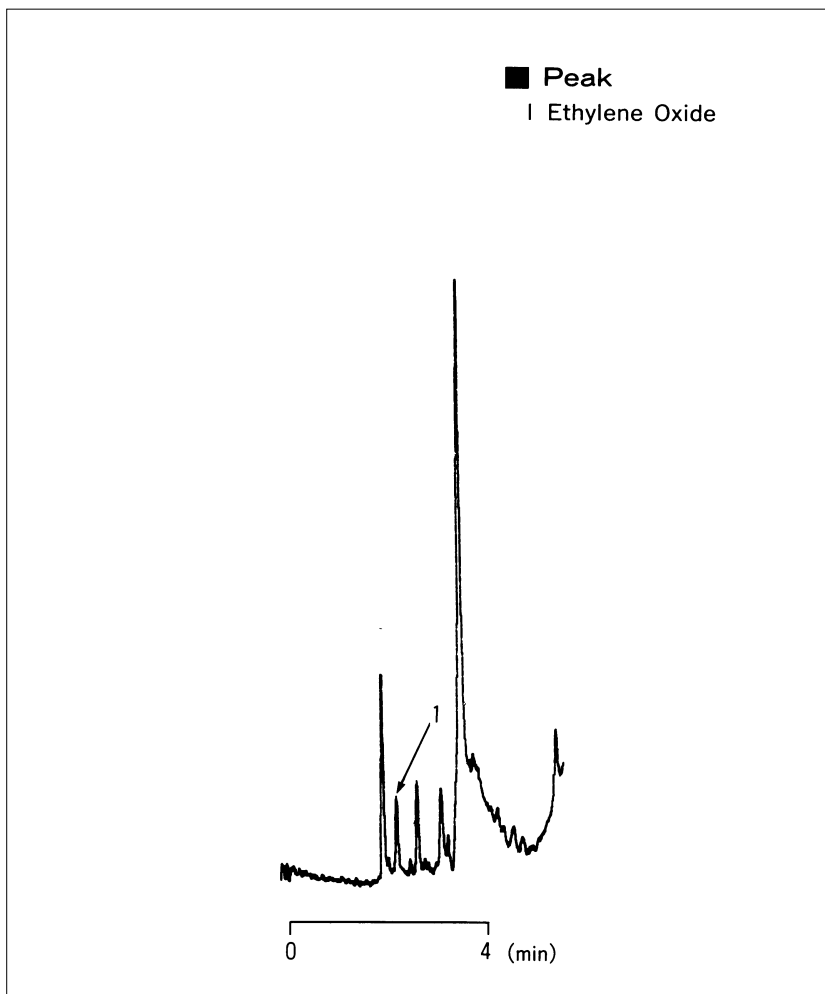

Fig. 5.19.1 Headspace gas chromatogram of three antiseptic first aid adhesive tapes



5.20 Simultaneous Analysis of Ascorbic Acid and Dehydroascorbic Acid (1) - LC

•Explanation

Ascorbic acid (AA) and dehydroascorbic acid (DHAA) are quantifiable nutrients as total vitamin C in the human body, which means they are widely analyzed in fields such as clinical medicine, biochemistry, food chemistry and pharmacology.

AA and DHAA separation is possible when both elements are being analyzed using the HPLC method. However, in comparison to AA, DHAA has a shorter local maximum of absorbency wavelength (225nm) and the absorbency coefficient is small so that actual measuring with the direct detection method is difficult because of low sensitivity. For this reason, DHAA is reduced to AA, quantified as the total ascorbic acid amount, and the

DHAA amount determined from the difference in pre-reduction and post-reduction quantitative values. Nevertheless, this requires manual operations, which can lead to human errors in the quantitative values.

Consequently, it was found that both elements will change to structures with a local maximum absorbency wavelength of 300nm in an alkali state, and, moreover, in this alkali state it was noted that DHAA sensitivity markedly increased with the addition of reduction agents like sodium borohydride (patent pending). Here, a series of analysis of both elements was performed using HPLC, and good results were obtained when the post column derivation method was applied to this detection method. This data introduces those results.

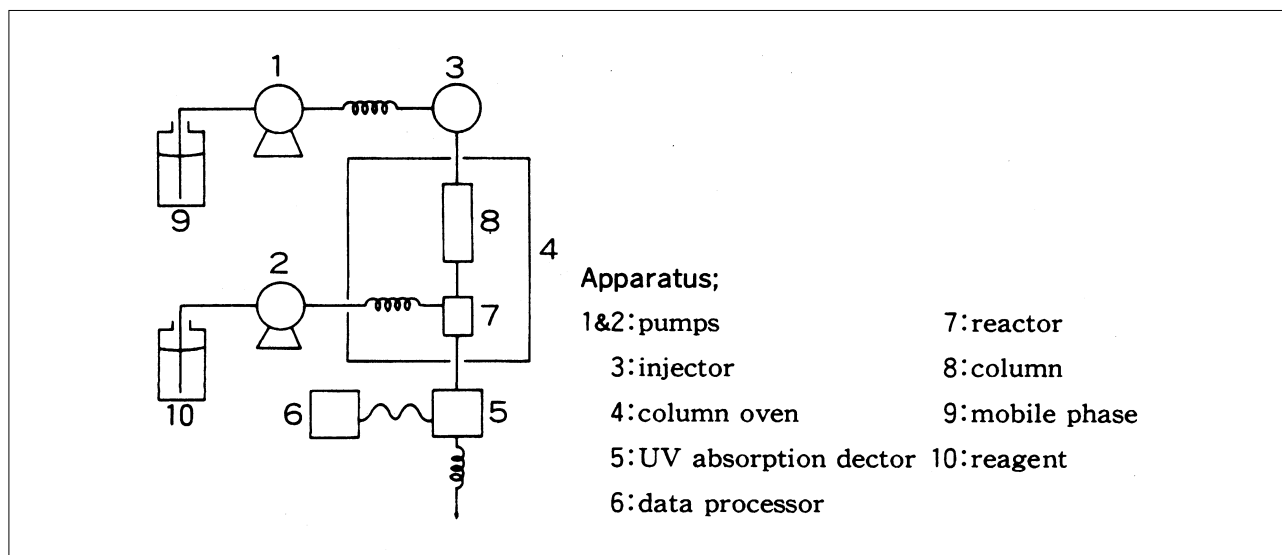

Fig. 5.20.1 System outline diagram

•Analytical Conditions

Instrument : HPLC

For Separation

Column : Shim-pack SCR-102H(300mmL. × 8mm i.d.)

Mobile Phase : 2mM Perchloric Acid Aqueous Solution

Flow Rate : 1.0mL/min

Temperature : 40°C

For Detection

Reagent : 100mM Sodium Hydroxide containing
100mM Sodium Borohydride

Flow Rate : 0.5mL/min

Reactor : Piping Part J

Temperature : 40°C

Detection : UV-VIS Detector 300nm

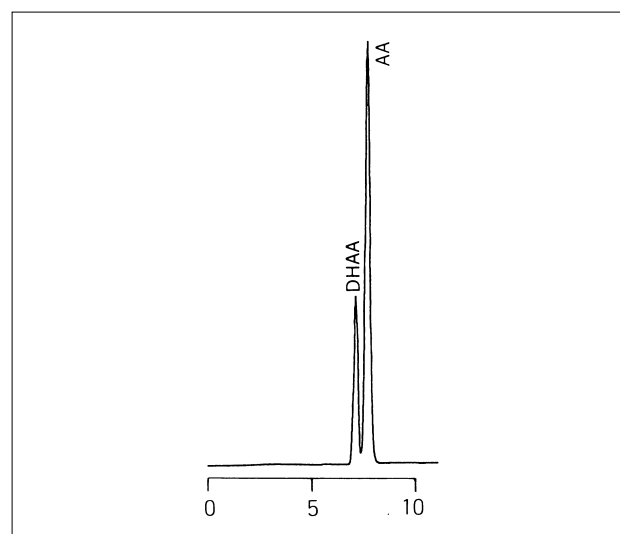

Fig. 5.20.2 Analysis of standard DHAA and AA

5.20 Simultaneous Analysis of Ascorbic Acid and Dehydroascorbic Acid (2) - LC

It was realized that both DHAA and AA change into compounds that possess the same absorbency spectrum patterns in the local maximum wavelength of 300nm using the previously explained alkali reaction agent. Fig. 5.20.3 shows the absorption spectrum comparison of both elements after the reaction. Even in the case of samples with multiple impure elements such as natural samples, straightforward pretreatment enables individual quantifying with detection selectivity. The results are for comparison data using tomato juice that was diluted by ten fold with distilled water, filtered and injected as sample of 10 μ L. Fig. 5.20.4 shows the direct detection results for an AA local maximum wavelength of 245nm

without taking a derivative. Fig. 5.20.5 shows the direct detection results for a DHAA local maximum wavelength of 225nm without taking a derivative. Fig. 5.20.6 shows analysis results using the derivative system.

The detection results showed favorable linearity in the ranges where the absolute injection volume for AA was 1ng to 2 μ g and 2ng to 2 μ g for DHAA. The detection limit was 750pg for AA and 1.7ng for DHAA, qualitative reproducibility for both AA and DHAA was 1% or less of the CV value (n = 10).

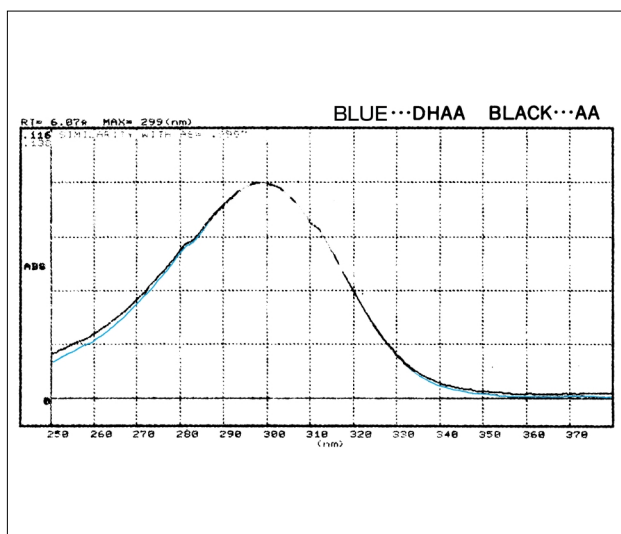

Fig. 5.20.3 DHAA and AA absorbency spectrums after derivation

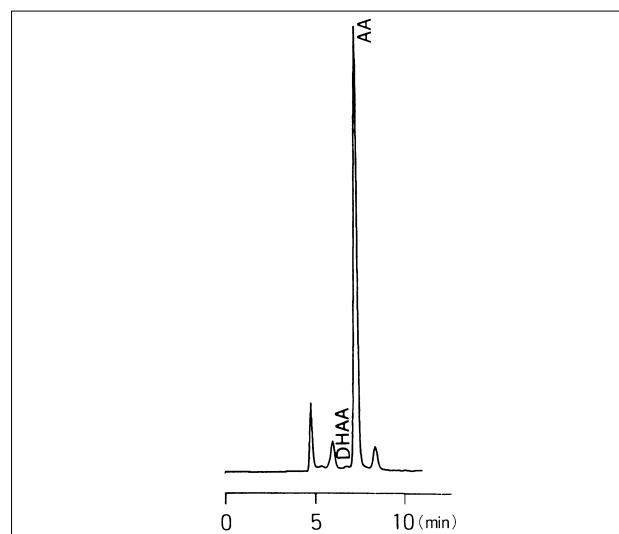

Fig. 5.20.4 Analysis of tomato juice using direct detection method (245nm)

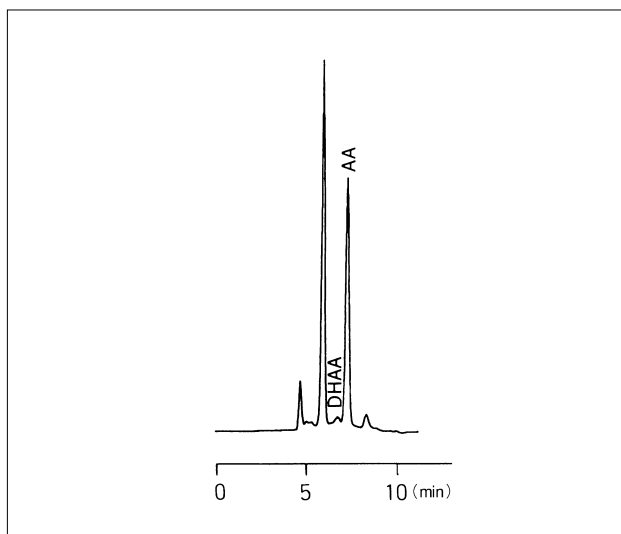

Fig. 5.20.5 Analysis of tomato juice using direct detection method (225nm)

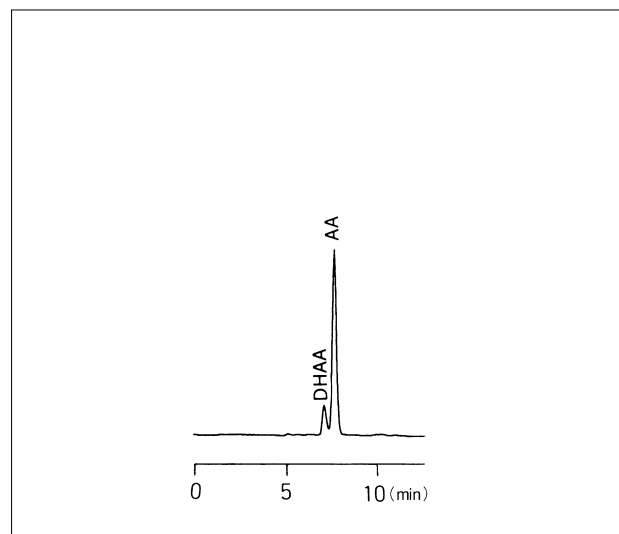

Fig. 5.20.6 Analysis of tomato juice using the derivatization method



5.21 Amino Acid Analysis (1) - LC

This data introduces analysis of 17 elements of sodium-type protein hydrolysate amino acid and 36 elements of lithium-type biogenic amino acid where each element

was separated for 33 min and 130 min periods respectively and analyzed in 45 min and 145 min cycles respectively.

◆ Analysis of 17 Elements of Protein Hydrolysate Amino Acid

● Pretreatment

The following shows sample pretreatment.

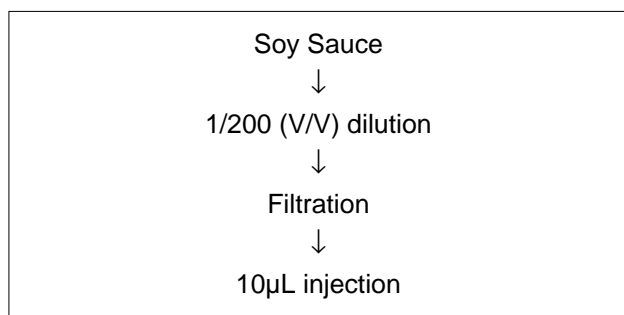

● Analytical Conditions

Instrument : HPLC
Column : Shim-pack Amino-Na
Mobile Phase : Na-type Amino Acid Mobile Phase Kit
Flow Rate : 0.6mL/min
Temp. : 60°C
Reagent : Amino Acid Reaction-Reagent Kit
Detection : Fluorescence Detector,
Ex = 350nm, Em = 450nm

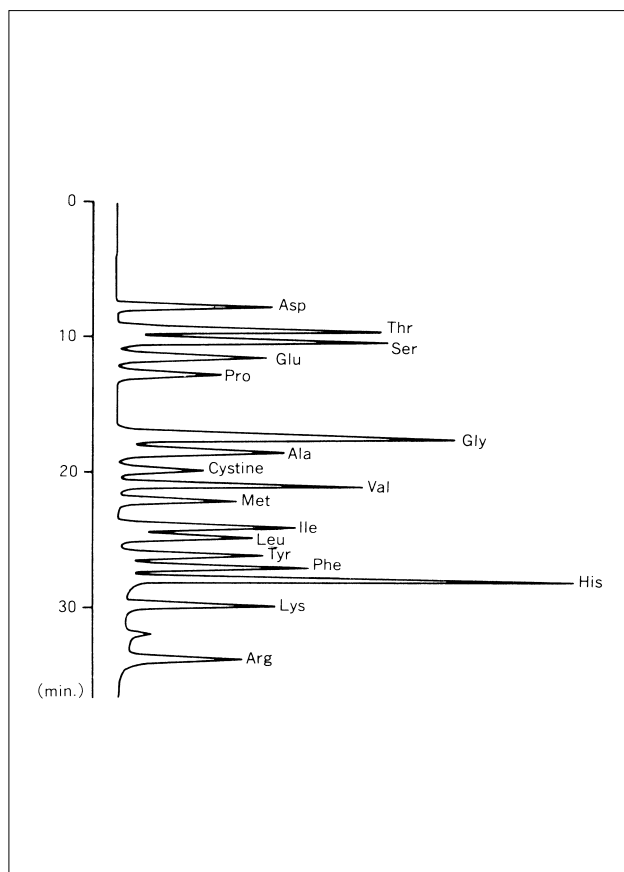

Fig. 5.21.1 Analysis example of 17 elements of standard amino acid

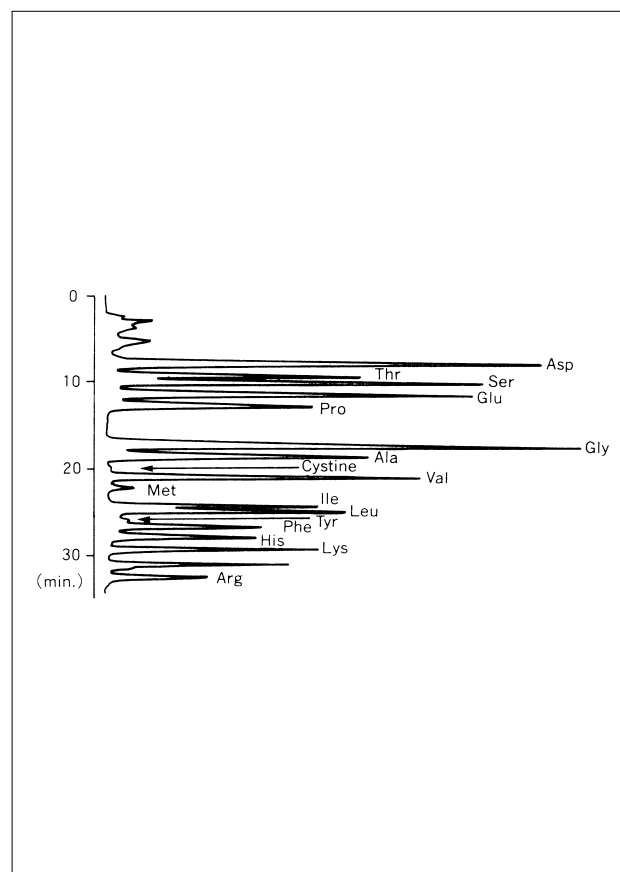
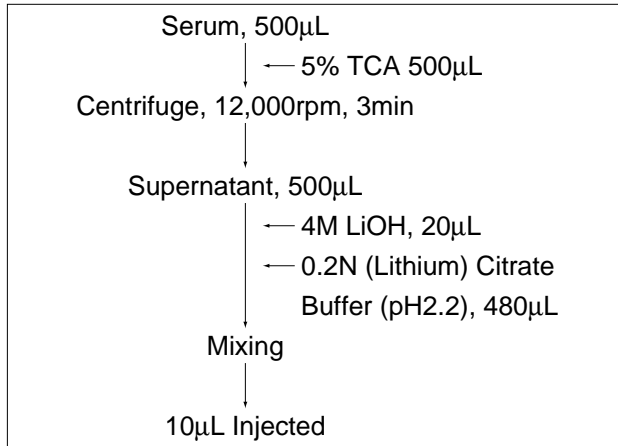

Fig. 5.21.2 Analysis example of amino acid in commercially available soy sauce

5.21 Amino Acid Analysis (2) - LC

◆ 36 Elements of Biogenic Amino Acid

● Pretreatment



● Analytical Conditions

Instrument : HPLC
 Column : Shim-pack Amino-Li
 Mobile Phase : Li-type Amino Acid Mobile Phase Kit
 Flow Rate : 0.6mL/min
 Temp. : 39°C
 Reagent : Amino Acid Reaction Reagent Kit
 Detection : Fluorescence Detector,
 Ex = 350nm, = 450nm

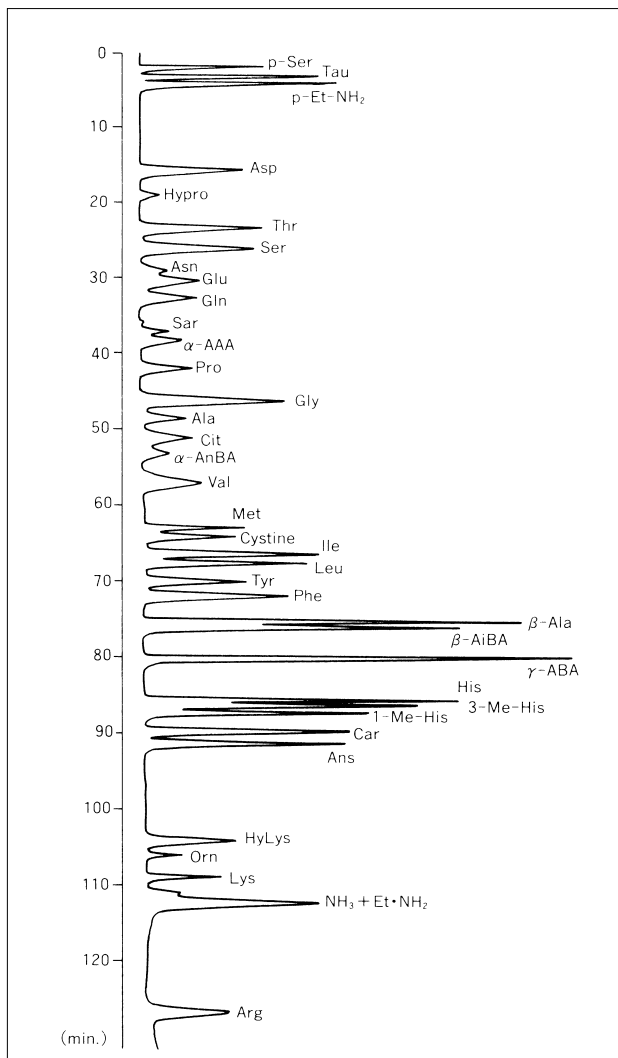

Fig. 5.21.3 Analysis example of 36 elements of standard amino acid

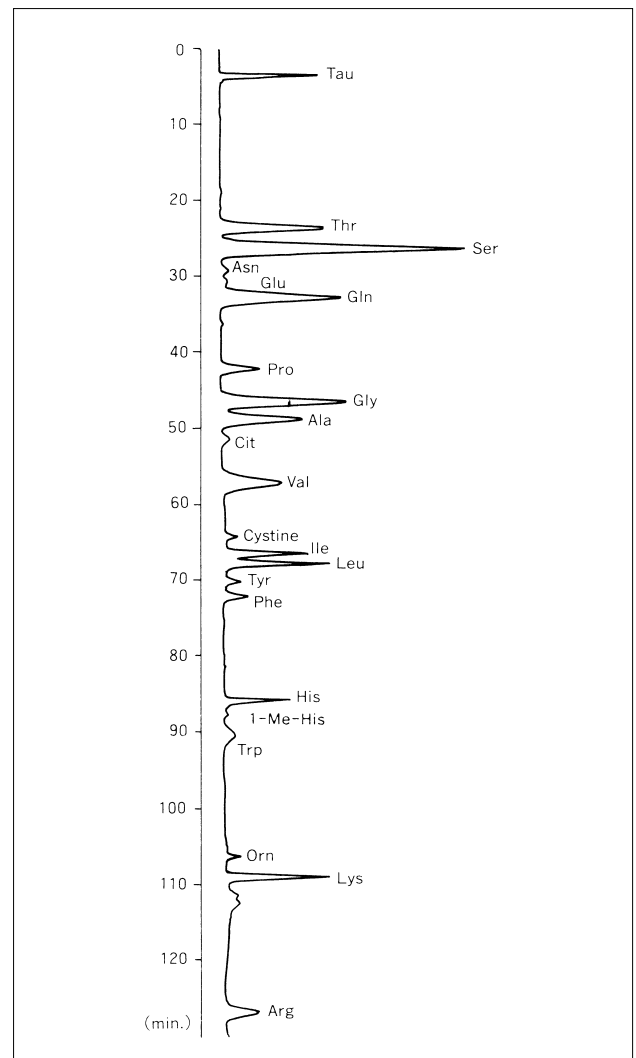

Fig. 5.21.4 Analysis example of amino acid in rat blood serum



5.22 Application in Combinatorial Chemistry - FTIR

•Explanation

In combinatorial synthesizing, the solid-phase synthesizing method provides a comparatively highly pure synthetic product with the merit of reactions occurring at multiple levels; however, this method has the demerit of being difficult to monitor in the reaction process. As a structure confirmation method for product material, mass spectrometry is often used, and with the solid-phase synthesizing method, a cut out from the resin is required. However, the FTIR is an effective method for analyzing structure during detection of solid-phase synthetics because it can directly confirm a structure without cutting out the product material from the resin. This data introduces measuring examples of peptide-synthesized resin (beads) using the ATR method.

•Instrument

There are several kinds of single-reflection level-type ATR devices, but for this analysis the diamond prism level-type ATR (Dura Sampl IR system H) was used.

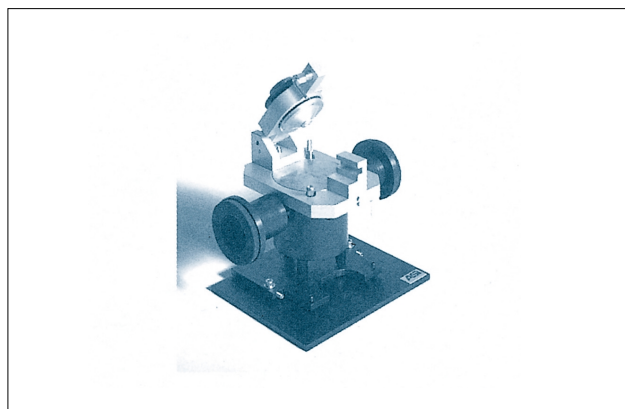

Fig. 5.22.1 External view of DuraSamplIR (system H)

•Results

A dummy compound is attached to the resin surface of the peptide synthetic and the device shown in Fig. 5.22.1 was used to measure this. Fig. 5.22.2 shows the spectrum of the compound-attached bead. Fig. 5.22.3 shows the spectrum of just the bead. And Fig. 5.22.4 shows the differential spectrum for both items. The peak of the substance attached to the surface of the bead can be confirmed in the differential spectrum.

In this way, this method - that enables easy measuring without pretreatment of resins in the process of being synthesized - shows great promise for future application as a method for confirming structures.

•Analytical Conditions

Accessory	: DuraSamplIR
Resolution	: 4cm ⁻¹
Accumulation	: 100
Apodization	: Happ-Genzel
Detector	: DLATGS

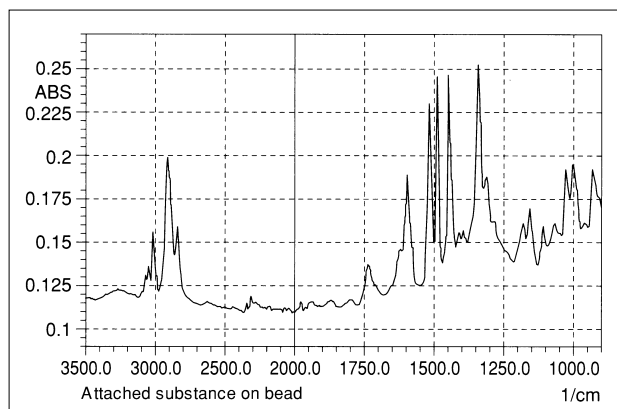

Fig. 5.22.2 ATR spectrum of substance attached to bead surface

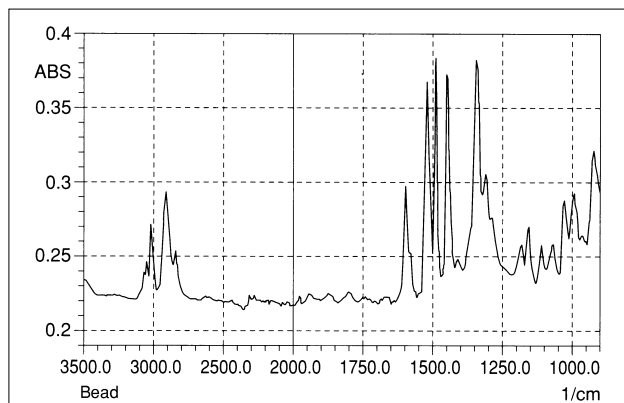

Fig. 5.22.3 ATR spectrum of bead

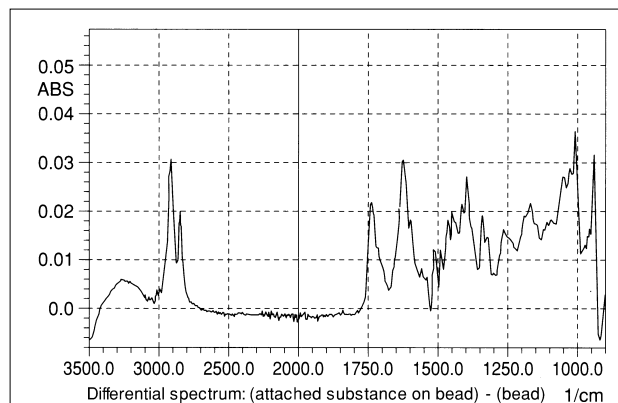

Fig. 5.22.4 Differential spectrum



SHIMADZU CORPORATION. International Marketing Division

3. Kanda-Nishikicho 1-chome, Chiyoda-ku, Tokyo 101-8448, Japan Phone: 81(3)3219-5641 Fax: 81(3)3219-5710
Cable Add.:SHIMADZU TOKYO

SHIMADZU SCIENTIFIC INSTRUMENTS, INC.

7102 Riverwood Drive, Columbia, Maryland 21046, U.S.A.
Phone: 1(410)381-1227 Fax: 1(410)381-1222 Toll Free: 1(800)477-1227

SHIMADZU DEUTSCHLAND GmbH

Albert-Hahn-Strasse 6-10, D-47269 Duisburg, F.R. Germany Phone: 49(203)7687-0 Fax: 49(203)766625

SHIMADZU (ASIA PACIFIC) PTE LTD.

16 Science Park Drive #01-01 Singapore Science Park, Singapore 118227, Republic of Singapore
Phone: 65-778 6280 Fax: 65-779 2935

SHIMADZU SCIENTIFIC INSTRUMENTS (OCEANIA) PTY. LTD.

Units F, 10-16 South Street Rydalmere N.S.W. 2116, Australia
Phone: 61(2)9684-4200 Fax: 61(2)9684-4055

SHIMADZU DO BRASIL COMERCIO LTDA.

Rua Cenno Sbrighi, 25, Agua Branca, Sao Paulo, CEP 05036-010, BRAZIL
Phone: (55)11-3611-1688 Fax: (55)11-3611-2209

SHIMADZU (HONG KONG) LIMITED

Suite 1028 Ocean Center, Harbour City, Tsim Sha Tsui, Kowloon HONG KONG
Phone: (852)2375-4979 Fax: (852)2199-7438

Overseas Offices

Istanbul, Beijing, Shanghai, Guangzhou, Shenyang, Chengdu, Moscow

URL <http://www.shimadzu.com>

Printed in Japan 3295-05113-10A-IK